



**The Only Real Alternative**

2016 Price List (£)

## Tiger Filtration Ltd - The Only Real Alternative

### Contents

	Page
Abac	1
AFE	2
ALMiG	3
Atlas Copco - Present	4
Atlas Copco - Previous	5
Atlas Copco - Previous	6
Becker	7
BOGE	8
Busch	9
Ceccato	10
Compair - Present	11
Compair - Previous	12
CTA	13
Deltech	14
Denco - NEW	15
Domnick Hunter - Present	16
Domnick Hunter - Previous	17
Domnick Hunter - Previous	18
DVP - NEW	19
Ecoair - NEW	20
Edwards	21
Filterworld - NEW	22
Friulair - FT	23
Friulair - FL	24

## Alternative Filter Elements



	Page
Gardner Denver - NEW	25
Hankison	26
Hi-Line - NEW	27
Hiross	28
HPC	29
Hydrovane	30
Hydrovane - Separators	31
Ingersoll Rand	32
Kaeser	33
Leybold	34
Mark	35
Mattei	36
Mattei - Separators	37
MiKROPOR	38
MTA	39
Omega	40
OMI - Present	41
OMI - Previous	42
Pall/PPC - NEW	43
Pneumatech	44
Puska	45
PVR - NEW	46
Rietschle	47
Sotras - NEW	48
Sullair	49
Tepro - NEW	50
Ultrafilter - 90 Series	51
Ultrafilter - 80 Series	52
Van Air Systems - NEW	53
Walker Filtration - Present	54
Walker Filtration - Present - NEW	55
Walker Filtration - Present - NEW	56
Walker Filtration - Previous	57
Worthington Creyssenac	58
Zander	59
Zeks	60

**Quality Products from Tiger Filtration Ltd** - Our range of Alternative Elements are designed and manufactured to perform "as good if not better" than the original equipment. All the materials used in the manufacture of these elements are sourced from recognised suppliers to the industry. We are so confident in our products that we offer a full 12 months "money back" guarantee if you are not happy with the performance. When you buy a product from **Tiger Filtration Ltd** you get a promise from the Managing Director that the elements are "as good if not better" than the original.



### Tiger Filtration Ltd

Unit 3, Rivergreen Industry Centre, Pallion, Sunderland, SR4 6AD, UK  
 Tel: +44 (0) 191 565 5348 Fax: +44 (0) 191 564 0002 Email: sales@tigerfiltration.co.uk



THE QUEEN'S AWARDS  
 FOR ENTERPRISE:  
 INTERNATIONAL TRADE  
 2011

## Tiger Filtration Ltd

### Abac

Alternative filter elements manufactured by **Tiger Filtration Ltd** to fit into **Abac** filter housings

## Alternative Filter Elements



Tiger P/No.	Abac P/No.	List Price £
AB60 (*)	(*) 60	23.00
AB80 (*)	(*) 80	26.00
AB120 (*)	(*) 120	35.00
AB200 (*)	(*) 200	45.00
AB340 (*)	(*) 340	60.00
AB510 (*)	(*) 510	74.00
AB800 (*)	(*) 800	93.00
AB1000 (*)	(*) 1000	127.00
AB1500 (*)	(*) 1500	150.00
AB2400 (*)	(*) 2400	238.00

(\*) = grade - Example: APFC60 order as AB60 M1  
M3 replaces AQFC (3 Micron)  
M1 replaces APFC (1 Micron)  
M0 replaces AEFC (0.1 Micron)  
MX replaces AHFC (0.01 Micron & 0.01mg/m<sup>3</sup> oil removal)  
AC replaces ACFC (Activated Carbon)



### Tiger Filtration Ltd

Unit 3, Rivergreen Industry Centre, Pallion, Sunderland, SR4 6AD, UK  
Tel: +44 (0) 191 565 5348 Fax: +44 (0) 191 564 0002 Email: sales@tigerfiltration.co.uk

## Tiger Filtration Ltd

## Alternative Filter Elements

### AFE

Alternative filter elements manufactured by **Tiger Filtration Ltd** to fit into **AFE** filter housings



Tiger P/No.	AFE P/No.	List Price £
AF10 (*)	EA10 (*)	46.00
AF15 (*)	EA15 (*)	55.00
AF20 (*)	EA20 (*)	63.00
AF30 (*)	EA30 (*)	80.00
AF55 (*)	EA55 (*)	105.00
AF95 (*)	EA95 (*)	136.00
AF150 (*)	EA150 (*)	175.00
AF220 (*)	EA220 (*)	216.00
AF290 (*)	EA290 (*)	287.00
AF430 (*)	EA430 (*)	340.00
AF625 (*)	EA625 (*)	480.00
AF775 (*)	EA775 (*)	628.00

(\*) = grade - Example: EA10U order as AF10 M1  
 M3 replaces P (3 Micron)  
 M1 replaces U (1 Micron)  
 MX replaces H (0.01 Micron & 0.01mg/m<sup>3</sup> oil removal)  
 AC replaces C (Activated Carbon)

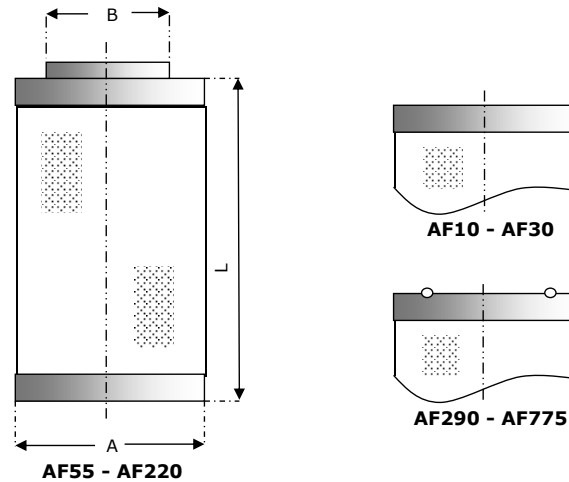

Tiger P/No.	A (mm)	B (mm)	L (mm)
AF10 (*)	51	24 (ID)	50
AF15 (*)	51	24 (ID)	61
AF20 (*)	51	24 (ID)	72
AF30 (*)	51	24 (ID)	140
AF55 (*)	75	63	110
AF95 (*)	75	63	210
AF150 (*)	75	63	310
AF220 (*)	75	63	500
AF290 (*)	91	67 (ID)	509
AF430 (*)	91	67 (ID)	766
AF625 (*)	140	100 (ID)	616
AF775 (*)	140	100 (ID)	751



### Tiger Filtration Ltd

Unit 3, Rivergreen Industry Centre, Pallion, Sunderland, SR4 6AD, UK  
 Tel: +44 (0) 191 565 5348 Fax: +44 (0) 191 564 0002 Email: sales@tigerfiltration.co.uk

## Tiger Filtration Ltd

### ALMiG

Alternative filter elements manufactured by **Tiger Filtration Ltd** to fit into **ALMiG** filter housings

## Alternative Filter Elements



Tiger P/No.	Almig P/No.	List Price £
AL30 (*)	(*) 30	25.00
AL60 (*)	(*) 60	29.00
AL108 (*)	(*) 108	38.00
AL180 (*)	(*) 180	41.00
AL204 (*)	(*) 204	44.00
AL300 (*)	(*) 300	52.00
AL432 (*)	(*) 432	58.00
AL570 (*)	(*) 570	77.00
AL750 (*)	(*) 750	100.00
AL990 (*)	(*) 990	122.00
AL1140 (*)	(*) 1140	131.00
AL1320 (*)	(*) 1320	171.00

(\*) = grade - Example: AFM30 order as AL30 M1

M5 replaces AFP (3 Micron)

M1 replaces AFM (1 Micron)

MX replaces AFS (0.01 Micron & 0.01mg/m<sup>3</sup> oil removal)

AC replaces AFC (Activated Carbon)



### Tiger Filtration Ltd

Unit 3, Rivergreen Industry Centre, Pallion, Sunderland, SR4 6AD, UK

Tel: +44 (0) 191 565 5348 Fax: +44 (0) 191 564 0002 Email: sales@tigerfiltration.co.uk

## Tiger Filtration Ltd

### Atlas Copco

Alternative filter elements manufactured by **Tiger Filtration Ltd** to fit into **Atlas Copco** filter housings

## Alternative Filter Elements



Grade M1 (DDp) 1 Micron

Tiger P/No.	AC P/No.	List Price £
AC9 M1	2901 0520 00	71.00
AC17 M1	2901 0613 00	93.00
AC32 M1	2901 0526 00	132.00
AC44 M1	2901 0529 00	151.00
AC60 M1	2901 0532 00	184.00
AC120 M1	2901 0535 00	222.00
AC150 M1	2901 0538 00	242.00
AC175 M1	2901 0541 00	259.00
AC260 M1	2901 0544 00	343.00
AC280 M1	2901 0544 00	343.00
AC390 M1	2906 7000 00	406.00
AC520 M1	2906 7003 00	465.00
AC-AX M1	1617 7073 03	380.00

Grade M1 (DD) 1 Micron

Tiger P/No.	AC P/No.	List Price £
AC9 M1	2901 0520 00	71.00
AC17 M1	2901 0613 00	93.00
AC32 M1	2901 0526 00	132.00
AC44 M1	2901 0529 00	151.00
AC60 M1	2901 0532 00	184.00
AC120 M1	2901 0535 00	222.00
AC150 M1	2901 0538 00	242.00
AC175 M1	2901 0541 00	259.00
AC260 M1	2901 0544 00	343.00
AC280 M1	2901 0544 00	343.00
AC390 M1	2906 7000 00	406.00
AC520 M1	2906 7003 00	465.00
AC-AX M1	1617 7073 03	380.00

Grade MX (PD) 0.01 Micron

Tiger P/No.	AC P/No.	List Price £
AC9 MX	2901 0521 00	71.00
AC17 MX	2901 0524 00	93.00
AC32 MX	2901 0527 00	132.00
AC44 MX	2901 0530 00	151.00
AC60 MX	2901 0533 00	184.00
AC120 MX	2901 0536 00	222.00
AC150 MX	2901 0539 00	242.00
AC175 MX	2901 0542 00	259.00
AC260 MX	2901 0545 00	343.00
AC280 MX	2901 0545 00	343.00
AC390 MX	2906 7001 00	406.00
AC520 MX	2906 7004 00	465.00
AC-AX MX	1617 7073 01	380.00

Grade AC (QD) Activated Carbon

Tiger P/No.	AC P/No.	List Price £
AC9 AC	2901 614 00	71.00
AC17 AC	2901 0525 00	93.00
AC32 AC	2901 0528 00	132.00
AC44 AC	2901 0531 00	151.00
AC60 AC	2901 0534 00	184.00
AC120 AC	2901 0537 00	222.00
AC150 AC	2901 0540 00	242.00
AC175 AC	2901 0543 00	259.00
AC260 AC	2901 0546 00	343.00
AC280 AC	2901 0546 00	343.00
AC390 AC	2906 7002 00	406.00
AC520 AC	2906 7005 00	465.00
AC-AX AC	1617 7073 02	380.00



### Tiger Filtration Ltd

Unit 3, Rivergreen Industry Centre, Pallion, Sunderland, SR4 6AD, UK

Tel: +44 (0) 191 565 5348 Fax: +44 (0) 191 564 0002 Email: sales@tigerfiltration.co.uk

## Tiger Filtration Ltd

### Atlas Copco - Previous

Alternative filter elements manufactured by **Tiger Filtration Ltd** to fit into **Atlas Copco** filter housings

## Alternative Filter Elements



Grade M1 (DD) 1 Micron

Tiger P/No.	AC P/No.	List Price £
AC190 M1	2901-0190-00	50.00
AC191 M1	2901-0191-00	80.00
AC234 M1	2901-0234-00	91.00
AC192 M1	2901-0192-00	113.00
AC193 M1	2901-0193-00	146.00
AC194 M1	2901-0194-00	179.00
AC213 M1	2906-0213-00	390.00
AC212 M1	2906-0212-00	297.00

Grade MX (PD) 0.01 Micron

Tiger P/No.	AC P/No.	List Price £
AC195 MX	2901-0195-00	50.00
AC196 MX	2901-0196-00	80.00
AC233 MX	2901-0233-00	91.00
AC197 MX	2901-0197-00	113.00
AC198 MX	2901-0198-00	146.00
AC199 MX	2901-0199-00	179.00
AC215 MX	2906-0215-00	390.00
AC214 MX	2906-0214-00	297.00

Grade AC (QD) Activated Carbon

Tiger P/No.	AC P/No.	List Price £
AC206 AC	2901-0206-00	241.00
AC201 ACC	2901-0201-00	29.00
AC203 ACC	2901-0203-00	47.00
AC235 ACC	2901-0235-00	92.00
AC205 ACC	2901-0205-00	119.00
AC217 AC	2901-0217-00	390.00
AC202 ACC	2901-0202-00	32.00
AC204 ACC	2901-0204-00	66.00
AC216 AC	2906-0216-00	297.00

Grade M1 (DD) 1 Micron

Tiger P/No.	AC P/No.	List Price £
AC625502 M1	1202-6255-02	50.00
AC625702 M1	1202-6257-02	80.00
AC625704 M1	1202-6257-04	91.00
AC625902 M1	1202-6259-02	113.00
AC625904 M1	1202-6259-04	146.00
AC626202 M1	1202-6262-02	179.00
AC857302 M1	1202-8573-02	297.00
AC627302 M1	1202-6273-02	390.00
AC626204 M1	1202-6262-04	234.00

Grade MX (PD) 0.01 Micron

Tiger P/No.	AC P/No.	List Price £
AC625501 MX	1202-6255-01	50.00
AC625701 MX	1202-6257-01	80.00
AC625703 MX	1202-6257-03	91.00
AC625901 MX	1202-6259-01	113.00
AC625903 MX	1202-6259-03	146.00
AC626201 MX	1202-6262-01	179.00
AC857301 MX	1202-8573-01	297.00
AC627301 MX	1202-6273-01	390.00
AC626203 MX	1202-6262-03	234.00

Grade AC (QD) Activated Carbon

Tiger P/No.	AC P/No.	List Price £
AC626400 ACC	1202-6264-00	29.00
AC628101 ACC	1202-6281-01	32.00
AC626801 ACC	1202-6268-01	47.00
AC628102 ACC	1202-6281-02	66.00
AC626802 ACC	1202-6268-02	92.00
AC626803 ACC	1202-6268-03	119.00
AC626301 AC	1202-6263-01	179.00
AC857200 AC	1202-8572-00	297.00
AC627400 AC	1202-6274-00	390.00
AC626302 AC	1202-6263-02	234.00

ACC = AC Element For Duplex Housing



### Tiger Filtration Ltd

Unit 3, Rivergreen Industry Centre, Pallion, Sunderland, SR4 6AD, UK

Tel: +44 (0) 191 565 5348 Fax: +44 (0) 191 564 0002 Email: sales@tigerfiltration.co.uk

## Tiger Filtration Ltd

### Atlas Copco - Previous

Alternative filter elements manufactured by **Tiger Filtration Ltd** to fit into **Atlas Copco** filter housings

## Alternative Filter Elements



Grade M5 (UFD) 5 Micron

Tiger P/No.	AC P/No.	List Price £
AC925 M5	9703-1925	96.00
AC926 M5	9703-1926	110.00
AC927 M5	9703-1927	142.00
AC928 M5	9703-1928	186.00
AC929 M5	9703-1929	212.00
AC930 M5	9703-1930	277.00
AC931 M5	9703-1931	367.00

Grade M1 (UDD) 1 Micron

Tiger P/No.	AC P/No.	List Price £
AC420 M1	9703-1420	96.00
AC421 M1	9703-1421	110.00
AC422 M1	9703-1422	142.00
AC423 M1	9703-1423	186.00
AC424 M1	9703-1424	212.00
AC425 M1	9703-1425	277.00
AC426 M1	9703-1426	367.00

Grade MX (UPD) 0.01 Micron

Tiger P/No.	AC P/No.	List Price £
AC442 MX	9703-1442	96.00
AC443 MX	9703-1443	110.00
AC444 MX	9703-1444	142.00
AC445 MX	9703-1445	186.00
AC446 MX	9703-1446	212.00
AC447 MX	9703-1447	277.00
AC448 MX	9703-1448	367.00

Grade AC (AC) Activated Carbon

Tiger P/No.	AC P/No.	List Price £
AC431 AC	9703-1431	96.00
AC432 AC	9703-1432	110.00
AC433 AC	9703-1433	142.00
AC434 AC	9703-1434	186.00
AC435 AC	9703-1435	212.00
AC436 AC	9703-1436	277.00
AC437 AC	9703-1437	367.00



### Tiger Filtration Ltd

Unit 3, Rivergreen Industry Centre, Pallion, Sunderland, SR4 6AD, UK

Tel: +44 (0) 191 565 5348 Fax: +44 (0) 191 564 0002 Email: [sales@tigerfiltration.co.uk](mailto:sales@tigerfiltration.co.uk)



## Tiger Filtration Ltd

### Becker

Alternative air/oil separator elements manufactured by **Tiger Filtration Ltd** to fit into **Becker** vacuum pumps

## Alternative Filter Elements



Tiger P/No.	Becker P/No.	List Price £
BK100 MF	6540100	26.00
BK402 MF	965402	59.00
BK403 MF	965403	70.00
BK404 MF	965404	31.00
BK406 MF	965406	72.00
BK409 MF	965409	48.00
BK410 MF	965410	180.00
BK411 MF	965411	219.00
BK412 MF	965412	48.00
BK413 MF	965413	35.00
BK414 MF	965414	34.00
BK415 MF	965415	45.00
BK416 MF	965416	43.00



### Tiger Filtration Ltd

Unit 3, Rivergreen Industry Centre, Pallion, Sunderland, SR4 6AD, UK

Tel: +44 (0) 191 565 5348 Fax: +44 (0) 191 564 0002 Email: [sales@tigerfiltration.co.uk](mailto:sales@tigerfiltration.co.uk)

## Tiger Filtration Ltd

### BOGE

Alternative filter elements manufactured by **Tiger Filtration Ltd** to fit into **BOGE** filter housings

## Alternative Filter Elements



Tiger P/No.	BOGE P/No.	List Price £
BG5 (*)	1/5 (*)	61.00
BG10 (*)	1/10 (*)	74.00
BG12 (*)	1/12 (*)	85.00
BG20 (*)	1/20 (*)	106.00
BG30 (*)	1/30 (*)	139.00
BG50 (*)	1/50 (*)	179.00
BG80 (*)	1/80 (*)	222.00
BG120 (*)	1/120 (*)	287.00
BG160 (*)	1/160 (*)	339.00
BG250 (*)	1/250 (*)	396.00
BG400 (*)	1/400 (*)	657.00

(\*) = grade - Example: 1/5 V order as BG5 M3  
M3 replaces V (3 Micron)  
MX replaces FP (0.01 Micron)  
AC replaces A (Activated Carbon)



### Tiger Filtration Ltd

Unit 3, Rivergreen Industry Centre, Pallion, Sunderland, SR4 6AD, UK  
Tel: +44 (0) 191 565 5348 Fax: +44 (0) 191 564 0002 Email: sales@tigerfiltration.co.uk

## Tiger Filtration Ltd

### Busch

Alternative air/oil separator elements manufactured by **Tiger Filtration Ltd** to fit into **Busch** vacuum pumps

## Alternative Filter Elements



Grade MF			Without Silencer
Tiger P/No.	Busch P/No.	O. D. Length	List Price £
BU101 MF	532-101	52mm/230mm	39.00
BU151 MF	532-151	35mm/56mm	18.00
BU216 MF	532-216	54mm/120mm	26.00
BU222 MF	532-222	54mm/200mm	26.00
BU221 MF	532-221	72mm/130mm	26.00
BU301 MF	532-301	52mm/230mm	39.00
BU302 MF	532-302	72mm/250mm	32.00
BU303 MF	532-303	72mm/375mm	49.00
BU304 MF	532-304	72mm/500mm	65.00

Grade MFS			With Silencer
Tiger P/No.	Busch P/No.	O. D. Length	List Price £
BU510 MFS	532-510	72mm/130mm	31.00
BU509 MFS	532-509	72mm/250mm	37.00
BU508 MFS	532-508	72mm/375mm	55.00
BU507 MFS	532-507	72mm/500mm	71.00
BU512 MFS	532-512	72mm/208mm	34.00

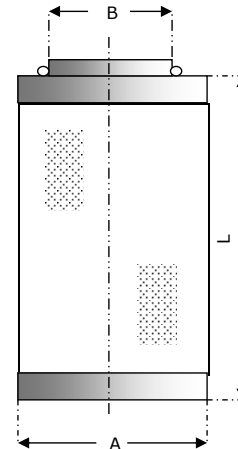

Tiger P/No.	A (mm)	B (mm)	L (mm)
BU101 MF	52	M22 thread	230
BU151 MF	35	3/8 BSP	56
BU216 MF	54	29	120
BU222 MF	54	29	200
BU221 MF	72	35	130
BU301 MF	52	M22 thread	230
BU302 MF	72	35	250
BU303 MF	72	35	375
BU304 MF	72	35	500
BU510 MFS	72	35	130
BU509 MFS	72	35	250
BU508 MFS	72	35	375
BU507 MFS	72	35	500
BU512 MFS	72	35	208



### Tiger Filtration Ltd

Unit 3, Rivergreen Industry Centre, Pallion, Sunderland, SR4 6AD, UK

Tel: +44 (0) 191 565 5348 Fax: +44 (0) 191 564 0002 Email: sales@tigerfiltration.co.uk

## Tiger Filtration Ltd

### Ceccato

Alternative filter elements manufactured by **Tiger Filtration Ltd** to fit into **Ceccato** filter housings

## Alternative Filter Elements



Tiger P/No.	Ceccato P/No.	List Price £
CE10 (*)	10 (*)	35.00
CE13 (*)	13 (*)	44.00
CE20 (*)	20 (*)	54.00
CE33 (*)	33 (*)	68.00
CE60 (*)	60 (*)	92.00
CE85 (*)	85 (*)	111.00
CE130 (*)	130 (*)	140.00
CE170 (*)	170 (*)	172.00
CE250 (*)	250 (*)	196.00
CE400 (*)	400 (*)	282.00

(\*) = grade - Example: 10FPRE order as CE10 M1  
M3 replaces FPRO (3 Micron)  
M1 replaces FPPE (1 Micron)  
M0 replaces FMO (0.1 Micron)  
MX replaces FMM (0.01 Micron)  
AC replaces FCA (Activated Carbon)



### Tiger Filtration Ltd

Unit 3, Rivergreen Industry Centre, Pallion, Sunderland, SR4 6AD, UK  
Tel: +44 (0) 191 565 5348 Fax: +44 (0) 191 564 0002 Email: sales@tigerfiltration.co.uk

## Tiger Filtration Ltd

### Compair

Alternative filter elements manufactured by **Tiger Filtration Ltd** to fit into **Compair** filter housings

## Alternative Filter Elements



Tiger P/No.	Compair P/No.	List Price £
CP0005 (*)	CE0005 (*)	44.00
CP0010 (*)	CE0010 (*)	68.00
CP0018 (*)	CE0018 (*)	79.00
CP0036 (*)	CE0036 (*)	104.00
CP0087 (*)	CE0087 (*)	133.00
CP0132 (*)	CE0132 (*)	151.00
CP0198 (*)	CE0198 (*)	206.00
CP0258 (*)	CE0258 (*)	276.00
CP0372 (*)	CE0372 (*)	349.00

(\*) = grade - Example: CE0005 B order as CP0005 M1  
 M25 replaces A (25 Micron)  
 M1 replaces B & E (1 Micron)  
 MX replaces C (0.01 Micron)  
 AC replaces D (Activated Carbon) - Single Stage Filter Housing

Grade ACC	Activated Carbon	Tiger P/No.	Compair P/No.	List Price £
		CP0004 ACC	CE0004 D	32.00
		CP0008 ACC	CE0008 D	35.00
		CP0015 ACC	CE0015 D	48.00
		CP0024 ACC	CE0024 D	66.00
		CP0039 ACC	CE0039 D	116.00
		CP0051 ACC	CE0051 D	146.00

ACC = AC Element For Duplex Housing



### Tiger Filtration Ltd

Unit 3, Rivergreen Industry Centre, Pallion, Sunderland, SR4 6AD, UK  
 Tel: +44 (0) 191 565 5348 Fax: +44 (0) 191 564 0002 Email: sales@tigerfiltration.co.uk

## Tiger Filtration Ltd

### Compair - Previous

Alternative filter elements manufactured by **Tiger Filtration Ltd** to fit into **Compair** filter housings

## Alternative Filter Elements



Grade M1(GPP) 1 Micron		
Tiger P/No.	Comp P/No.	List Price £
CP21 M1	98245/121	38.00
CP22 M1	98245/122	63.00
CP23 M1	98245/123	74.00
CP25 M1	98245/125	91.00
CP26 M1	98245/126	119.00
CP27 M1	98245/127	143.00
CP28 M1	98245/128	206.00
CP29 M1	98245/129	329.00
CP30 M1	98245/130	243.00

Grade MX(OFP) 0.01 Micron		
Tiger P/No.	Comp P/No.	List Price £
CP41 MX	98245/141	38.00
CP42 MX	98245/142	63.00
CP43 MX	98245/143	74.00
CP45 MX	98245/145	91.00
CP46 MX	98245/146	119.00
CP47 MX	98245/147	143.00
CP48 MX	98245/148	206.00
CP49 MX	98245/149	329.00
CP50 MX	98245/150	243.00

Grade AC(OVR) Activated Carbon		
Tiger P/No.	Comp P/No.	List Price £
CP61 ACC	98245/161	32.00
CP62 ACC	98245/162	35.00
CP63 ACC	98245/163	48.00
CP64 ACC	98245/164	116.00
CP65 ACC	98245/165	66.00
CP66 ACC	98245/166	146.00
CP67 AC	98245/167	143.00
CP68 AC	98245/168	206.00
CP69 AC	98245/169	329.00
CP70 AC	98245/170	243.00

Grade M1(GPP) 1 Micron		
Tiger P/No.	Comp P/No.	List Price £
CP22 M1	98245/21	63.00
CP23 M1	98245/22	74.00
CP25 M1	98245/23	91.00
CP26 M1	98245/25	119.00
CP27 M1	98245/27	143.00
CP28 M1	98245/28	206.00
CP29 M1	98245/29	329.00

Grade MX(OFP) 0.01 Micron		
Tiger P/No.	Comp P/No.	List Price £
CP42 MX	98245/41	63.00
CP43 MX	98245/42	74.00
CP45 MX	98245/43	91.00
CP46 MX	98245/45	119.00
CP47 MX	98245/47	143.00
CP48 MX	98245/48	206.00
CP49 MX	98245/49	329.00

Grade AC(OVR) Activated Carbon		
Tiger P/No.	Comp P/No.	List Price £
CP62 ACC	98245/62	35.00
CP65 ACC	98245/65	66.00
CP67 AC	98245/67	143.00
CP68 AC	98245/68	206.00

ACC = AC Element For Duplex Housing



### Tiger Filtration Ltd

Unit 3, Rivergreen Industry Centre, Pallion, Sunderland, SR4 6AD, UK

Tel: +44 (0) 191 565 5348 Fax: +44 (0) 191 564 0002 Email: sales@tigerfiltration.co.uk

## Tiger Filtration Ltd

## Alternative Filter Elements

### C.T.A.

Alternative filter elements manufactured by **Tiger Filtration Ltd** to fit into **C.T.A.** filter housings



Tiger P/No.	CTA P/No.	List Price £
CT5050 (*)	05050 (*)	34.00
CT6050 (*)	06050 (*)	39.00
CT7050 (*)	07050 (*)	46.00
CT14050 (*)	14050 (*)	57.00
CT12075 (*)	12075 (*)	74.00
CT22075 (*)	22075 (*)	95.00
CT32075 (*)	32075 (*)	117.00
CT50075 (*)	50075 (*)	150.00
CT51090 (*)	51090 (*)	182.00
CT76090 (*)	76090 (*)	210.00
CT75140 (*)	75140 (*)	297.00

(\*) = grade - Example: 05050 M order as CT5050 M1  
 M3 replaces P (3 Micron)  
 M1 replaces M (1 Micron)  
 MX replaces S (0.01 Micron)  
 AC replaces A (Activated Carbon)

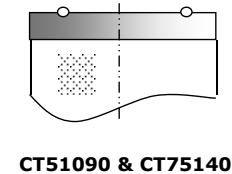
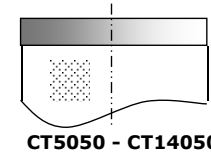
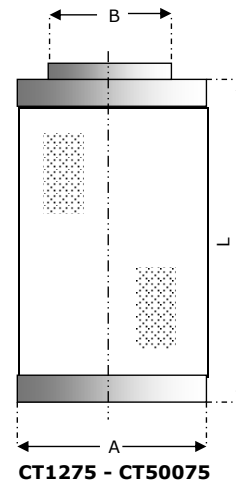

Tiger P/No.	A (mm)	B (mm)	L (mm)
CT5050 (*)	51	24 (ID)	50
CT6050 (*)	51	24 (ID)	61
CT7050 (*)	51	24 (ID)	72
CT14050 (*)	51	24 (ID)	140
CT12075 (*)	75	63	119
CT22075 (*)	75	63	219
CT32075 (*)	75	63	319
CT50075 (*)	75	63	500
CT51090 (*)	91	67 (ID)	509
CT76090 (*)	91	67 (ID)	766
CT75140 (*)	140	100 (ID)	751



### Tiger Filtration Ltd

Unit 3, Rivergreen Industry Centre, Pallion, Sunderland, SR4 6AD, UK  
 Tel: +44 (0) 191 565 5348 Fax: +44 (0) 191 564 0002 Email: sales@tigerfiltration.co.uk

## Tiger Filtration Ltd

### Deltech

Alternative filter elements manufactured for **Tiger Filtration Ltd** to fit into **Deltech** filter housings

## Alternative Filter Elements



<b>Tiger P/No.</b>	<b>Deltech P/No.</b>	<b>List Price £</b>
DE9 (*)	(*) D 9	POA
DE18 (*)	(*) D 18	POA
DE36 (*)	(*) D 36	POA
DE54 (*)	(*) D 54	POA
DE90 (*)	(*) D 90	POA
DE135 (*)	(*) D 135	POA
DE216 (*)	(*) D 216	POA
DE285 (*)	(*) D 285	POA
DE405 (*)	(*) D 405	POA
DE540 (*)	(*) D 540	POA
DE750 (*)	(*) D 750	POA

(\*) = grade - Example: PFD 9 order as DE9 M1  
M1 replaces PF & DF (1 Micron)  
MX replaces HF (0.01 Micron & 0.01mg/m<sup>3</sup> oil removal)  
AC replaces CF (Activated Carbon)



### Tiger Filtration Ltd

Unit 3, Rivergreen Industry Centre, Pallion, Sunderland, SR4 6AD UK  
Tel: +44 (0) 191 565 5348 Fax: +44 (0) 191 564 0002 Email: [sales@tigerfiltration.co.uk](mailto:sales@tigerfiltration.co.uk)



## Tiger Filtration Ltd

### Denco

Alternative filter elements manufactured by **Tiger Filtration Ltd** to fit into **Denco** filter housings

## Alternative Filter Elements



Tiger P/No.	Denco P/No.	List Price £
DC12 (*)	(*)DC12	53.00
DC15 (*)	(*)DC15	53.00
DC17 (*)	(*)DC17	61.00
DC22 (*)	(*)DC22	71.00
DC23 (*)	(*)DC23	76.00
DC32 (*)	(*)DC32	81.00
DC42 (*)	(*)DC42	90.00
DC44 (*)	(*)DC44	99.00
DC52 (*)	(*)DC52	109.00
DC62 (*)	(*)DC62	197.00
DC64 (*)	(*)DC64	218.00
DC72 (*)	(*)DC72	252.00
DC82 (*)	(*)DC82	276.00
DC85 (*)	(*)DC85	299.00

(\*) = grade - Example: 01DC12 order as DC12 M1

M5 replaces 05 (5 Micron)

M1 replaces 01 (1 Micron)

MX replaces 00 (0.01 Micron & 0.01mg/m<sup>3</sup> oil removal)

AC stays as AC (Activated Carbon)



### Tiger Filtration Ltd

Unit 3, Rivergreen Industry Centre, Pallion, Sunderland, SR4 6AD, UK

Tel: +44 (0) 191 565 5348 Fax: +44 (0) 191 564 0002 Email: sales@tigerfiltration.co.uk

## Tiger Filtration Ltd

## Alternative Filter Elements

### Domnick Hunter (Parker)

Alternative filter elements manufactured by **Tiger Filtration Ltd** to fit into **Domnick Hunter (Parker)** filter housings



Tiger P/No.	DH P/No.	List Price £
DH009 (*)	K009 (*)	38.00
DH017 (*)	K017 (*)	63.00
DH030 (*)	K030 (*)	74.00
DH058 (*)	K058 (*)	91.00
DH145 (*)	K145 (*)	119.00
DH220 (*)	K220 (*)	143.00
DH330 (*)	K330 (*)	206.00
DH430 (*)	K430 (*)	243.00
DH620 (*)	K620 (*)	329.00

(\*) = grade - Example: K009 AO order as DH009 M1  
 M25 replaces PF (25 Micron)  
 M1 replaces AO (1 Micron)  
 MX replaces AA (0.01 Micron & 0.01mg/m<sup>3</sup> oil removal)  
 MXX replaces AX (0.01 Micron & 0.001mg/m<sup>3</sup> oil removal)  
 AC replaces ACS (Activated Carbon) - Single Stage Filter Housing

Grade ACC	Activated Carbon	List Price £
Tiger P/No.	DH P/No.	List Price £
DH006 ACC	K006 AC	32.00
DH013 ACC	K013 AC	35.00
DH025 ACC	K025 AC	48.00
DH040 ACC	K040 AC	66.00
DH065 ACC	K065 AC	116.00
DH085 ACC	K085 AC	146.00

ACC = AC Element For Duplex Housing



### Tiger Filtration Ltd

Unit 3, Rivergreen Industry Centre, Pallion, Sunderland, SR4 6AD, UK  
 Tel: +44 (0) 191 565 5348 Fax: +44 (0) 191 564 0002 Email: sales@tigerfiltration.co.uk

## Tiger Filtration Ltd

## Alternative Filter Elements

### Domnick Hunter (Parker) - Previous

Alternative filter elements manufactured by **Tiger Filtration Ltd** to fit into **Domnick Hunter (Parker)** filter housings



<b>Tiger P/No.</b>	<b>DH P/No.</b>	<b>List Price £</b>
DH006 (*)	K006 (*)	38.00
DH013 (*)	K013 (*)	63.00
DH025 (*)	K025 (*)	74.00
DH040 (*)	K040 (*)	91.00
DH085 (*)	K085 (*)	119.00
DH195 (*)	K195 (*)	143.00
DH295 (*)	K295 (*)	206.00
DH400 (*)	K400 (*)	243.00
DH500 (*)	K500 (*)	329.00

(\*) = grade - Example: K006 AO order as DH006 M1

M25 replaces PF (25 Micron)

M1 replaces AO (1 Micron)

MX replaces AA (0.01 Micron & 0.01mg/m<sup>3</sup> oil removal)

MXX replaces AX (0.01 Micron & 0.001mg/m<sup>3</sup> oil removal)

AC replaces ACS with the exception of K006 AC which is replaced by DH006 ACC



### Tiger Filtration Ltd

Unit 3, Rivergreen Industry Centre, Pallion, Sunderland, SR4 6AD, UK

Tel: +44 (0) 191 565 5348 Fax: +44 (0) 191 564 0002 Email: [sales@tigerfiltration.co.uk](mailto:sales@tigerfiltration.co.uk)

## Tiger Filtration Ltd

### Domnick Hunter (Parker) - Previous

Alternative filter elements manufactured by **Tiger Filtration Ltd** to fit into **Domnick Hunter (Parker)** filter housings

## Alternative Filter Elements



Tiger P/No.	DH P/No.	List Price £
DH007 (*)	E007 (*)	63.00
DH011 (*)	E011 (*)	74.00
DH035 (*)	E035 (*)	91.00
DH060 (*)	E060 (*)	119.00
DH120 (*)	E120 (*)	143.00
DH200 (*)	E200 (*)	206.00
DH250 (*)	E250 (*)	206.00
DH300 (*)	E300 (*)	329.00
DH360 (*)	E360 (*)	329.00

(\*) = grade - Example: E007 AO order as DH007 M1  
M25 replaces PF (25 Micron)  
M1 replaces AO (1 Micron)  
MX replaces AA (0.01 Micron & 0.01mg/m<sup>3</sup> oil removal)

Tiger P/No.	DH P/No.	List Price £
DH007 (*)	E007 (*)	63.00
DH011 (*)	E011 (*)	74.00
DH035 (*)	E035 (*)	91.00
DH060 (*)	E060 (*)	119.00
DH085 (*)	E085 (*)	119.00
DH120 (*)	E120 (*)	143.00
DH195 (*)	E195 (*)	143.00
DH200 (*)	E200 (*)	206.00
DH250 (*)	E250 (*)	206.00
DH295 (*)	E295 (*)	206.00
DH300 (*)	E300 (*)	329.00
DH360 (*)	E360 (*)	329.00
DH500 (*)	E500 (*)	329.00

(\*) = grade - Example: E007 AOTS order as DH007 M1  
M1 replaces AOTS (1 Micron)  
MX replaces AATS (0.01 Micron)

Grade AC		Activated Carbon
Tiger P/No.	DH P/No.	List Price £
DH011 ACC	ABN 1	47.00
DH011 ACC	E011 AC	47.00
DH060 ACC	E060 AC	66.00
DH120 AC	E120 AC	143.00
DH200 AC	E200 AC	206.00
DH250 AC	E250 AC	206.00
DH300 AC	E300 AC	329.00
DH360 AC	E360 AC	329.00

ACC = AC Element For Duplex Housing



### Tiger Filtration Ltd

Unit 3, Rivergreen Industry Centre, Pallion, Sunderland, SR4 6AD, UK  
Tel: +44 (0) 191 565 5348 Fax: +44 (0) 191 564 0002 Email: sales@tigerfiltration.co.uk

## Tiger Filtration Ltd

### DVP

Alternative air/oil separator elements manufactured by **Tiger Filtration Ltd** to fit into **DVP** vacuum pumps

## Alternative Filter Elements



Tiger P/No.	DVP P/No.	Pump Model	List Price £
DV1846	1801046	LB2/3/4/5/6	18.00
DV9033	9001033	LB8, LA12, LC12	27.00
DV9046	9001046	LB18/25, LV25, LA20	29.00
DV1873	1801073	LC25	33.00

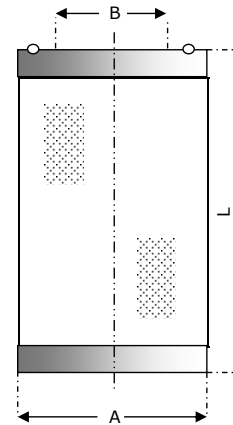

Tiger P/No.	A (mm)	B (mm)	L (mm)
DV1846	34	3/8" BSP	56
DV9033	45	20	62
DV9046	45	20	100
DV1873	45	20	150



### Tiger Filtration Ltd

Unit 3, Rivergreen Industry Centre, Pallion, Sunderland, SR4 6AD, UK

Tel: +44 (0) 191 565 5348 Fax: +44 (0) 191 564 0002 Email: sales@tigerfiltration.co.uk

## Tiger Filtration Ltd

### Ecoair

Alternative filter elements manufactured by **Tiger Filtration Ltd** to fit into **Ecoair** filter housings

## Alternative Filter Elements



<b>Tiger P/No.</b>	<b>Ecoair P/No.</b>	<b>List Price £</b>
EC01 (*)	E(*) 01	70.00
EC02 (*)	E(*) 02	82.00
EC03 (*)	E(*) 03	100.00
EC04 (*)	E(*) 04	133.00
EC05 (*)	E(*) 05	171.00
EC06 (*)	E(*) 06	212.00
EC07 (*)	E(*) 07	273.00
EC08 (*)	E(*) 08	322.00
EC09 (*)	E(*) 09	377.00
EC10 (*)	E(*) 10	625.00

(\*) = grade - Example: EF 01 order as EC01 M1  
M3 replaces V (3 Micron)  
M1 replaces F (1 Micron)  
MX replaces S (0.01 Micron & 0.01mg/m<sup>3</sup> oil removal)  
AC replaces A (Activated Carbon)



### Tiger Filtration Ltd

Unit 3, Rivergreen Industry Centre, Pallion, Sunderland, SR4 6AD, UK

Tel: +44 (0) 191 565 5348 Fax: +44 (0) 191 564 0002 Email: [sales@tigerfiltration.co.uk](mailto:sales@tigerfiltration.co.uk)

## Tiger Filtration Ltd

## Alternative Filter Elements

### Edwards

Alternative air/oil separator elements manufactured by **Tiger Filtration Ltd** to fit into **Edwards** vacuum pumps



Tiger P/No.	Edwards P/No.	List Price £
ED 057	A223 04 057	72.00
ED 020	A223 04 020	81.00
ED 021	A223 04 021	92.00

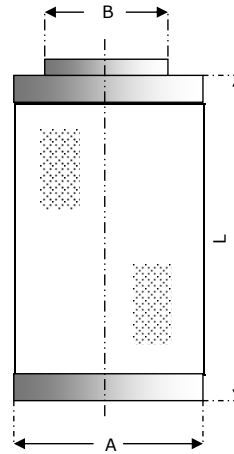

Tiger P/No.	A (mm)	B (mm)	L (mm)
ED057	80	31	173
ED020	80	31	252
ED021	80	55	380



### Tiger Filtration Ltd

Unit 3, Rivergreen Industry Centre, Pallion, Sunderland, SR4 6AD, UK

Tel: +44 (0) 191 565 5348 Fax: +44 (0) 191 564 0002 Email: sales@tigerfiltration.co.uk

## Tiger Filtration Ltd

### Filterworld

Alternative filter elements manufactured by **Tiger Filtration Ltd** to fit into **Filterworld** filter housings

## Alternative Filter Elements



Tiger P/No.	FW P/No.	List Price £
FW05 (*)	(*)C05	50.00
FW12 (*)	(*)C12	54.00
FW15 (*)	(*)C15	54.00
FW17 (*)	(*)C17	62.00
FW22 (*)	(*)C22	72.00
FW23 (*)	(*)C23	78.00
FW32 (*)	(*)C32	82.00
FW42 (*)	(*)C42	92.00
FW44 (*)	(*)C44	101.00
FW52 (*)	(*)C52	111.00
FW62 (*)	(*)C62	201.00
FW64 (*)	(*)C64	222.00
FW72 (*)	(*)C72	256.00
FW82 (*)	(*)C82	281.00
FW85 (*)	(*)C85	305.00

(\*) = grade - Example: 01C12 order as FW12 M1  
M25 replaces 25 (25 Micron)  
M5 replaces 05 (5 Micron)  
M1 replaces 01 (1 Micron)  
MX replaces 00 (0.01 Micron & 0.01mg/m<sup>3</sup> oil removal)  
AC stays as AC (Activated Carbon)



### Tiger Filtration Ltd

Unit 3, Rivergreen Industry Centre, Pallion, Sunderland, SR4 6AD, UK  
Tel: +44 (0) 191 565 5348 Fax: +44 (0) 191 564 0002 Email: sales@tigerfiltration.co.uk



## Tiger Filtration Ltd

## Alternative Filter Elements

### Friulair

Alternative filter elements manufactured by **Tiger Filtration Ltd** to fit into **Friulair** filter housings



Tiger P/No.	Friulair P/No.	List Price £
FT008 (*)	T (*) 008	29.00
FT012 (*)	T (*) 012	34.00
FT018 (*)	T (*) 018	43.00
FT030 (*)	T (*) 030	54.00
FT055 (*)	T (*) 055	73.00
FT080 (*)	T (*) 080	87.00
FT120 (*)	T (*) 120	109.00
FT160 (*)	T (*) 160	156.00
FT220 (*)	T (*) 220	234.00
FT250 (*)	T (*) 250	186.00
FT400 (*)	T (*) 400	243.00

(\*) = grade - Example: TS008 order as FT008 M1  
 M5 replaces P (5 Micron)  
 M1 replaces S (1 Micron)  
 MX replaces X (0.01 Micron & 0.01mg/m<sup>3</sup> oil removal)  
 AC replaces Z (Activated Carbon)

N.B. The FT220 (\*) element is for multi-candle fabricated vessels

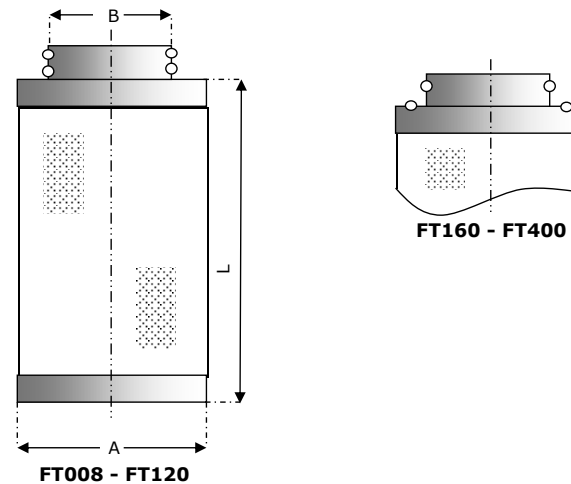

Tiger P/No.	A (mm)	B (mm)	L (mm)
FT008	51	23	61
FT012	51	23	72
FT018	51	23	140
FT030	75	45	119
FT055	75	45	219
FT080	75	45	319
FT120	75	45	497
FT160	91	71	509
FT220	91	71	680
FT250	91	71	766
FT400	140	102	751



### Tiger Filtration Ltd

Unit 3, Rivergreen Industry Centre, Pallion, Sunderland, SR4 6AD, UK  
 Tel: +44 (0) 191 565 5348 Fax: +44 (0) 191 564 0002 Email: sales@tigerfiltration.co.uk

## Tiger Filtration Ltd

## Alternative Filter Elements

### Friulair - Previous

Alternative filter elements manufactured by **Tiger Filtration Ltd** to fit into **Friulair** filter housings



Tiger P/No.	Friulair P/No.	List Price £
FL008 (*)	L (*) 008	29.00
FL011 (*)	L (*) 011	34.00
FL018 (*)	L (*) 018	43.00
FL031 (*)	L (*) 031	54.00
FL052 (*)	L (*) 052	73.00
FL075 (*)	L (*) 075	87.00
FL118 (*)	L (*) 118	109.00
FL168 (*)	L (*) 168	156.00
FL250 (*)	L (*) 250	186.00
FL400 (*)	L (*) 400	243.00

(\*) = grade - Example: LS008 order as FL008 M1  
 M5 replaces P (5 Micron)  
 M1 replaces S (1 Micron)  
 MX replaces X (0.01 Micron & 0.01mg/m<sup>3</sup> oil removal)  
 AC replaces Z (Activated Carbon)

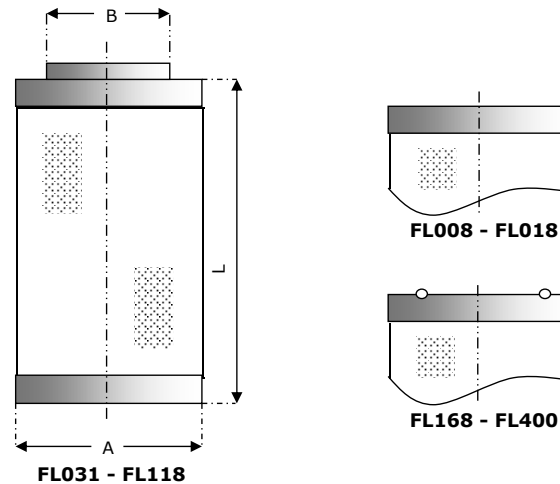

Tiger P/No.	A (mm)	B (mm)	L (mm)
FL008	51	24 (ID)	61
FL011	51	24 (ID)	72
FL018	51	24 (ID)	140
FL031	75	63	119
FL052	75	63	219
FL075	75	63	319
FL118	75	63	497
FL168	91	67 (ID)	509
FL250	91	67 (ID)	766
FL400	140	100 (ID)	751



### Tiger Filtration Ltd

Unit 3, Rivergreen Industry Centre, Pallion, Sunderland, SR4 6AD, UK  
 Tel: +44 (0) 191 565 5348 Fax: +44 (0) 191 564 0002 Email: sales@tigerfiltration.co.uk

## Tiger Filtration Ltd

## Alternative Filter Elements

### Gardner Denver

Alternative air/oil separator elements manufactured by **Tiger Filtration Ltd** to fit into **Gardner Denver** air compressors



Tiger P/No.	GD P/No.	List Price £
GD03267728	3267728	POA
GD03340028	3340028	POA
GD60455401	60455401	POA
GD60455801	60455801	POA
GD89848519	89848519	POA



### Tiger Filtration Ltd

Unit 3, Rivergreen Industry Centre, Pallion, Sunderland, SR4 6AD, UK

Tel: +44 (0) 191 565 5348 Fax: +44 (0) 191 564 0002 Email: [sales@tigerfiltration.co.uk](mailto:sales@tigerfiltration.co.uk)

## Tiger Filtration Ltd

### Hankison

Alternative filter elements manufactured by **Tiger Filtration Ltd** to fit into **Hankison** filter housings

## Alternative Filter Elements



Tiger P/No.	Hankison P/No.	List Price £
HK12 (*)	E (*) -12	45.00
HK16 (*)	E (*) - 16	60.00
HK20 (*)	E (*) - 20	79.00
HK24 (*)	E (*) - 24	99.00
HK28 (*)	E (*) - 28	123.00
HK32 (*)	E (*) - 32	138.00
HK36 (*)	E (*) - 36	173.00
HK40 (*)	E (*) - 40	206.00
HK44 (*)	E (*) - 44	231.00
HK52PV (*)	E (*) - 52PV	247.00
HK48 (*)	E (*) - 48	239.00
HK54 (*)	E (*) - 54	239.00

(\*) = grade - Example: E7-12 order as HK12 M1

M5 replaces 9 (5 Micron)

M1 replaces 7 (1 Micron)

MX replaces 5 (0.01 Micron & 0.01mg/m<sup>3</sup> oil removal)

MXX replaces 3 (0.01 Micron & 0.001mg/m<sup>3</sup> oil removal)

AC replaces 1 (Activated Carbon)

N.B. The HK52PV (\*) is for multi-candle fabricated vessels



### Tiger Filtration Ltd

Unit 3, Rivergreen Industry Centre, Pallion, Sunderland, SR4 6AD, UK

Tel: +44 (0) 191 565 5348 Fax: +44 (0) 191 564 0002 Email: sales@tigerfiltration.co.uk

## Tiger Filtration Ltd

### Hi-Line

Alternative filter elements manufactured by **Tiger Filtration Ltd** to fit into **Hi-Line** filter housings

## Alternative Filter Elements



Tiger P/No.	Hi-Line P/No.	List Price £
HL25 (*)	HE25-(* )	48.00
HL36 (*)	HE36-(* )	58.00
HL50 (*)	HE50-(* )	66.00
HL72 (*)	HE72-(* )	84.00
HL120 (*)	HE120-(* )	110.00
HL210 (*)	HE210-(* )	143.00
HL320 (*)	HE320-(* )	183.00
HL500 (*)	HE500-(* )	228.00
HL630 (*)	HE630-(* )	302.00
HL850 (*)	HE850-(* )	356.00
HL1400 (*)	HE1400-(* )	504.00
HL1700 (*)	HE1700-(* )	660.00

(\*) = grade - Example: HE25-3 order as HL25 M1  
 M3 replaces 2 (3 Micron)  
 M1 replaces 3 (1 Micron)  
 MX replaces 4 (0.01 Micron & 0.01mg/m<sup>3</sup> oil removal)  
 AC replaces 5 (Activated Carbon)

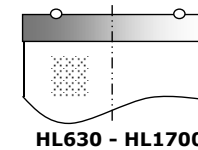
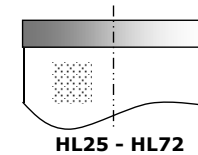
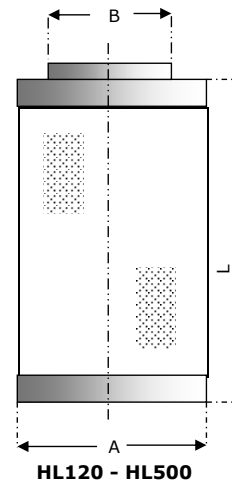

Tiger P/No.	A (mm)	B (mm)	L (mm)
HL25-(* )	51	24(ID)	51
HL36-(* )	51	24(ID)	61
HL50-(* )	51	24(ID)	72
HL72-(* )	51	24(ID)	140
HL120-(* )	75	63	110
HL210-(* )	75	63	210
HL320-(* )	75	63	310
HL500-(* )	75	63	500
HL630-(* )	91	67 (ID)	509
HL850-(* )	91	67 (ID)	766
HL1400-(* )	140	100 (ID)	616
HL1700-(* )	140	100 (ID)	751



### Tiger Filtration Ltd

Unit 3, Rivergreen Industry Centre, Pallion, Sunderland, SR4 6AD, UK

Tel: +44 (0) 191 565 5348 Fax: +44 (0) 191 564 0002 Email: sales@tigerfiltration.co.uk

## Tiger Filtration Ltd

### Hiross (Parker)

Alternative filter elements manufactured by **Tiger Filtration Ltd** to fit into **Hiross (Parker)** filter housings

## Alternative Filter Elements



Tiger P/No.	Hiross P/No.	List Price £
HR005 (*)	005 (*)	43.00
HR010 (*)	002 (*) - 004 (*) - 006 (*) - 010 (*)	43.00
HR016 (*)	007 (*) - 009 (*) - 016 (*)	54.00
HR022 (*)	(*) - 015 (*) - 018 (*) - 020 (*) - 022	61.00
HR030 (*)	024 (*) - 030 (*)	64.00
HR045 (*)	035 (*) - 045 (*)	71.00
HR072 (*)	060 (*) - 062 (*) - 072 (*)	90.00
HR135 (*)	090 (*) - 110 (*) - 122 (*) - 135 (*)	124.00
HR175 (*)	175 (*)	140.00
HR205 (*)	120 (*) - 151 (*) - 205 (*)	159.00
HR180 (*)	150 (*) - 180 (*)	172.00
HR250 (*)	250 (*)	172.00
HR260 (*)	260 (*)	245.00
HR280 (*)	240 (*) - 280 (*)	260.00
HR300 (*)	300 (*)	220.00
HR370 (*)	370 (*)	306.00

(\*) = grade - Example: 005P order as HR005 M1

M5 replaces Q (5 Micron)

M1 replaces P (1 Micron)

MX replaces S (0.01 Micron)

AC replaces C (Activated Carbon)

N.B. The HR250 element is for fabricated housing with multiple elements and will be supplied with a 13.5mm dia through hole.



### Tiger Filtration Ltd

Unit 3, Rivergreen Industry Centre, Pallion, Sunderland, SR4 6AD, UK

Tel: +44 (0) 191 565 5348 Fax: +44 (0) 191 564 0002 Email: sales@tigerfiltration.co.uk

## Tiger Filtration Ltd

### HPC

Alternative filter elements manufactured by **Tiger Filtration Ltd** to fit into **HPC** filter housings

Tiger P/No.	HPC P/No.	List Price £
HP009 (*)	K009 (*)	38.00
HP017 (*)	K017 (*)	63.00
HP030 (*)	K030 (*)	74.00
HP058 (*)	K058 (*)	91.00
HP145 (*)	K145 (*)	119.00
HP220 (*)	K220 (*)	143.00
HP330 (*)	K330 (*)	206.00
HP430 (*)	K430 (*)	243.00
HP620 (*)	K620 (*)	329.00

(\*) = grade - Example: K009 AO order as HP009 M1  
 M1 replaces AO (1 Micron)  
 MX replaces AA (0.01 Micron & 0.01mg/m<sup>3</sup> oil removal)

Tiger P/No.	HPC P/No.	List Price £
HP006 (*)	K006 (*)	38.00
HP013 (*)	K013 (*)	63.00
HP025 (*)	K025 (*)	74.00
HP040 (*)	K040 (*)	91.00
HP085 (*)	K085 (*)	119.00
HP195 (*)	K195 (*)	143.00
HP295 (*)	K295 (*)	206.00
HP400 (*)	K400 (*)	243.00
HP500 (*)	K500 (*)	329.00

(\*) = grade - Example: K006 AO order as HP006 M1  
 M1 replaces AO (1 Micron)  
 MX replaces AA (0.01 Micron & 0.01mg/m<sup>3</sup> oil removal)

## Alternative Filter Elements



Grade AC		Activated Carbon	
Tiger P/No.	HPC P/No.	Tiger P/No.	HPC P/No.
HP006 ACC	K006 AC	HP006 ACC	K006 AC
HP013 ACC	K013 AC	HP013 ACC	K013 AC
HP025 ACC	K025 AC	HP025 ACC	K025 AC
HP040 ACC	K040 AC	HP040 ACC	K040 AC
HP065 ACC	K065 AC	HP065 ACC	K065 AC
HP085 ACC	K085 AC	HP085 ACC	K085 AC
HP195 AC	K195 AC	HP195 AC	K195 AC
HP295 AC	K295 AC	HP295 AC	K295 AC
HP400 AC	K400 AC	HP400 AC	K400 AC
HP500 AC	K500 AC	HP500 AC	K500 AC

ACC = AC Element For Duplex Housing



### Tiger Filtration Ltd

Unit 3, Rivergreen Industry Centre, Pallion, Sunderland, SR4 6AD, UK  
 Tel: +44 (0) 191 565 5348 Fax: +44 (0) 191 564 0002 Email: sales@tigerfiltration.co.uk

## Tiger Filtration Ltd

### Hydrovane

Alternative filter elements manufactured by **Tiger Filtration Ltd** to fit into **Hydrovane** filter housings

## Alternative Filter Elements



Tiger P/No.	Hydro P/No.	List Price £
HY100 (*)	(*) 100 E	38.00
HY150 (*)	(*) 150 E	63.00
HY200 (*)	(*) 200 E	74.00
HY250 (*)	(*) 250 E	91.00
HY350 (*)	(*) 350 E	119.00
HY450 (*)	(*) 450 E	143.00
HY500 (*)	(*) 500 E	206.00
HY530 (*)	(*) 530 E	243.00
HY600 (*)	(*) 600 E	329.00

(\*) = grade - Example: GP100 E order as HY100 M1  
 M1 replaces GP & DR (1 Micron)  
 MX replaces HE (0.01 Micron & 0.01mg/m<sup>3</sup> oil removal)

Grade AC	Activated Carbon	
Tiger P/No.	Hydro P/No.	List Price £
HY100 ACC	OR100 E	32.00
HY150 ACC	OR150 E	35.00
HY200 ACC	OR200 E	48.00
HY250 ACC	OR250 E	66.00
HY300 ACC	OR300 E	116.00
HY350 ACC	OR350 E	146.00
HY450 AC	OR450 E	143.00
HY500 AC	OR500 E	206.00
HY530 AC	OR530 E	243.00
HY600 AC	OR600 E	329.00

ACC = Activated Carbon Element For Duplex Housing



### Tiger Filtration Ltd

Unit 3, Rivergreen Industry Centre, Pallion, Sunderland, SR4 6AD, UK  
 Tel: +44 (0) 191 565 5348 Fax: +44 (0) 191 564 0002 Email: sales@tigerfiltration.co.uk



## Tiger Filtration Ltd

## Alternative Filter Elements

### Hydrovane

Alternative air/oil separator elements manufactured by **Tiger Filtration Ltd** to fit into **Hydrovane** air compressors



Tiger P/No.	Hydro P/No.	List Price £
HY52022	52022	31.00
HY3415	3415	31.00
HY3407	3407	31.00
HY52471	52471	31.00
HY57029	57029	31.00
HY59177	59177	33.00
HY70166	70166	21.00
HY70539	70539	33.00
HY59180	59180	33.00

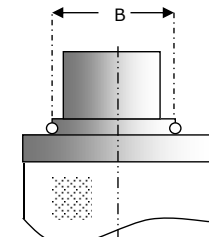
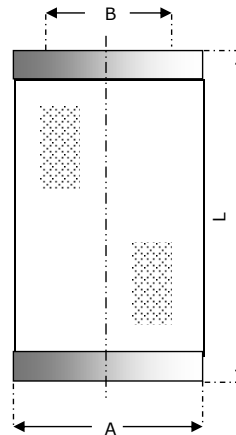

**HY70539 & HY59180**

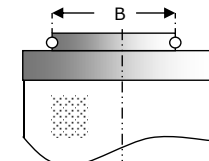

**HY57029 & HY59177**

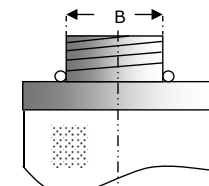

**HY70166**

Tiger P/No.	A (mm)	B (mm)	L (mm)
HY52022	70	40 (ID)	70
HY3415	70	40 (ID)	200
HY3407	70	40 (ID)	255
HY52471	70	40 (ID)	175
HY57029	70	40	84
HY59177	70	40	204
HY70166	21.5	1/8" BSP	31
HY70539	70	40	204
HY59180	70	40	255



### Tiger Filtration Ltd

Unit 3, Rivergreen Industry Centre, Pallion, Sunderland, SR4 6AD, UK  
 Tel: +44 (0) 191 565 5348 Fax: +44 (0) 191 564 0002 Email: sales@tigerfiltration.co.uk

## Tiger Filtration Ltd

### Ingersoll Rand

Alternative filter elements manufactured by **Tiger Filtration Ltd** to fit into **Ingersoll Rand** filter housings

## Alternative Filter Elements



			Grade AC	Activated Carbon		
Tiger P/No.	IR P/No.	List Price £	Tiger P/No.	IR P/No.	List Price £	
IR5 (*)	5 (*)	38.00	IR5 AC	5 ACS	38.00	
IR10 (*)	10 (*)	63.00	IR10 AC	10 ACS	63.00	
IR18 (*)	18 (*)	74.00	IR18 AC	18 ACS	74.00	
IR36 (*)	36 (*)	91.00	IR36 AC	36 ACS	91.00	
IR48 (*)	48 (*)	119.00	IR48 AC	48 ACS	119.00	
IR119 (*)	119 (*)	143.00	IR119 AC	119 ACS	143.00	
IR198 (*)	198 (*)	206.00	IR198 AC	198 ACS	206.00	
IR239 (*)	239 (*)	243.00	IR239 AC	239 ACS	243.00	
IR372 (*)	372 (*)	329.00	IR372 AC	372 ACS	329.00	

(\*) = grade - Example: 5 AO order as IR5 M1  
 M1 replaces AO & AR (1 Micron)  
 MX replaces AA (0.01 Micron & 0.01mg/m<sup>3</sup> oil removal)

			Grade AC	Activated Carbon		
Tiger P/No.	IR P/No.	List Price £	Tiger P/No.	IR P/No.	List Price £	
IR4 (*)	E4 (*)	38.00	IR4 ACC	E4 AC	32.00	
IR8 (*)	E8 (*)	63.00	IR8 ACC	E8 AC	33.00	
IR15 (*)	E15 (*)	74.00	IR15 ACC	E15 AC	48.00	
IR24 (*)	E24 (*)	91.00	IR24 ACC	E24 AC	66.00	
IR50 (*)	E50 (*)	119.00	IR39 ACC	E39 AC	116.00	
IR125 (*)	E125 (*)	143.00	IR50 ACC	E50 AC	146.00	
IR180 (*)	E180 (*)	206.00	IR125 AC	E125 AC	143.00	
IR240 (*)	E240 (*)	243.00	IR180 AC	E180 AC	206.00	
IR300 (*)	E300 (*)	329.00	IR240 AC	E240 AC	243.00	
			IR300 AC	E300 AC	329.00	

(\*) = grade - Example: E4 AO order as IR4 M1  
 M1 replaces AO & AR (1 Micron)  
 MX replaces AA (0.01 Micron & 0.01mg/m<sup>3</sup> oil removal)



### Tiger Filtration Ltd

Unit 3, Rivergreen Industry Centre, Pallion, Sunderland, SR4 6AD, UK  
 Tel: +44 (0) 191 565 5348 Fax: +44 (0) 191 564 0002 Email: sales@tigerfiltration.co.uk

## Tiger Filtration Ltd

### Kaeser

Alternative filter elements manufactured by **Tiger Filtration Ltd** to fit into **Kaeser** filter housings

## Alternative Filter Elements



Tiger P/No.	Kaeser P/No.	List Price £
KS006 (*)	E - (*) - 6	45.00
KS010 (*)	E - (*) - 10	60.00
KS018 (*)	E - (*) - 18	79.00
KS028 (*)	E - (*) - 28	99.00
KS048 (*)	E - (*) - 48	123.00
KS071 (*)	E - (*) - 71	138.00
KS107 (*)	E - (*) - 107	173.00
KS138 (*)	E - (*) - 138	203.00
KS177 (*)	E - (*) - 177	231.00
KS185 (*)	E - (*) - 185	247.00
KS221 (*)	E - (*) - 221	239.00
KS283 (*)	E - (*) - 283	239.00

(\*) = grade - Example: E-C-6 order as KS006 M1

M5 replaces B (5 Micron)

M1 replaces C (1 Micron)

MX replaces E (0.01 Micron & 0.01mg/m<sup>3</sup> oil removal)

MXX replaces F (0.01 Micron & 0.001mg/m<sup>3</sup> oil removal)

AC replaces G (Activated Carbon)

RM1 replaces D (1 micron)



### Tiger Filtration Ltd

Unit 3, Rivergreen Industry Centre, Pallion, Sunderland, SR4 6AD, UK

Tel: +44 (0) 191 565 5348 Fax: +44 (0) 191 564 0002 Email: sales@tigerfiltration.co.uk

## Tiger Filtration Ltd

## Alternative Filter Elements

### Leybold

Alternative air/oil separator elements manufactured by **Tiger Filtration Ltd** to fit into **Leybold** vacuum pumps



Tiger P/No.	Leybold P/No.	Pump Model	List Price £
LY023	712-32-023	SV16 - 25	59.00
LY763	710-64-763	SV40 - 200	70.00
LY773	710-64-773	SV280 - 1200	81.00
LY180	714-21-180	SV40B	44.00
LY300	714-17-300	SV65B - 100B	48.00
LY120	714-31-120	SV200B,300B,630B,750B	57.00
LY971	18971	D4A-B-AC,D8B,D2A-AC	45.00
LY973	18973	D40B-BCS, D65B-BCS	52.00
LY975	18975	D8A, D16A	45.00

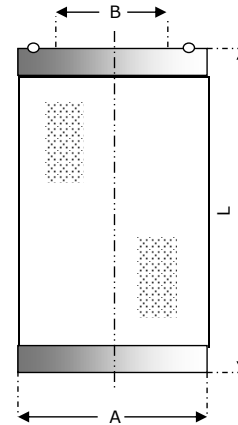

Tiger P/No.	A (mm)	B (mm)	L (mm)
LY023	55	24 (ID)	152
LY763	66	40 (ID)	228
LY773	66	40 (ID)	400
LY180	73	47.5 (ID)	188
LY300	73	47.5 (ID)	225
LY120	73	47.5 (ID)	401
LY971	54	25 (ID)	75
LY973	54	25 (ID)	175
LY975	54	25 (ID)	95



### Tiger Filtration Ltd

Unit 3, Rivergreen Industry Centre, Pallion, Sunderland, SR4 6AD, UK

Tel: +44 (0) 191 565 5348 Fax: +44 (0) 191 564 0002 Email: sales@tigerfiltration.co.uk

## Tiger Filtration Ltd

### Mark

Alternative filter elements manufactured by **Tiger Filtration Ltd** to fit into **Mark** filter housings

## Alternative Filter Elements



Tiger P/No.	Mark P/No.	List Price £
MK10 (*)	10 (*)	35.00
MK13 (*)	13 (*)	44.00
MK20 (*)	20 (*)	54.00
MK33 (*)	33 (*)	68.00
MK60 (*)	60 (*)	92.00
MK85 (*)	85 (*)	111.00
MK130 (*)	130 (*)	140.00
MK170 (*)	170 (*)	172.00
MK250 (*)	250 (*)	196.00
MK400 (*)	400 (*)	282.00

(\*) = grade - Example: 10FPRE order as MK10 M1

M3 replaces FPRO (3 Micron)

M1 replaces FPPE (1 Micron)

M0 replaces FMO (0.1 Micron)

MX replaces FMM (0.01 Micron)

AC replaces FCA (Activated Carbon)



### Tiger Filtration Ltd

Unit 3, Rivergreen Industry Centre, Pallion, Sunderland, SR4 6AD, UK

Tel: +44 (0) 191 565 5348 Fax: +44 (0) 191 564 0002 Email: sales@tigerfiltration.co.uk

## Tiger Filtration Ltd

### Mattei

Alternative filter elements manufactured by **Tiger Filtration Ltd** to fit into **Mattei** filter housings

## Alternative Filter Elements



Tiger P/No.	Mattei P/No.	List Price £
MA005 (*)	04E 0030 (*)	25.00
MA010 (*)	04E 0060 (*)	29.00
MA018 (*)	04E 0108 (*)	38.00
MA030 (*)	04E 0180 (*)	41.00
MA034 (*)	04E 0204 (*)	44.00
MA050 (*)	04E 0300 (*)	52.00
MA072 (*)	04E 0432 (*)	58.00
MA095 (*)	04E 0570 (*)	77.00
MA125 (*)	04E 0750 (*)	100.00
MA165 (*)	04E 0990 (*)	122.00
MA190 (*)	04E 1140 (*)	131.00
MA220 (*)	04E 1320 (*)	171.00

(\*) = grade - Example: 04E 0030 PF order as MA005 M1  
M25 replaces D (25 Micron)  
M5 replaces Q (5 Micron)  
M1 replaces P (1 Micron)  
MX replaces H (0.01 Micron & 0.01mg/m<sup>3</sup> oil removal)  
MXX replaces S (0.01 Micron & 0.001mg/m<sup>3</sup> oil removal)  
AC replaces C (Activated Carbon)



### Tiger Filtration Ltd

Unit 3, Rivergreen Industry Centre, Pallion, Sunderland, SR4 6AD, UK  
Tel: +44 (0) 191 565 5348 Fax: +44 (0) 191 564 0002 Email: sales@tigerfiltration.co.uk

## Tiger Filtration Ltd

### Mattei

Alternative air/oil separator elements manufactured by **Tiger Filtration Ltd** to fit into **Mattei** air compressors

Grade M1/RM1 1 Micron

Tiger P/No.	Mattei P/No.	List Price £
MA20113	CR2201130	37.00
MA30725	CR21F30725	33.00
MA30732	CR21A30732	31.00
MA30733	CR21H30733	41.00

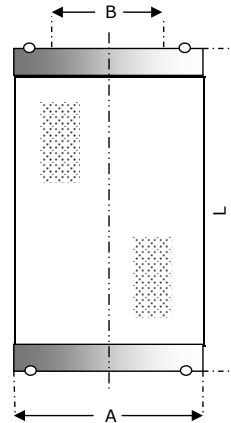

Tiger P/No.	A (mm)	B (mm)	L (mm)
MA20113	100	70 (ID)	252
MA30725	70	40 (ID)	200
MA30732	70	40 (ID)	255
MA30733	70	40 (ID)	400

## Alternative Filter Elements



### Tiger Filtration Ltd

Unit 3, Rivergreen Industry Centre, Pallion, Sunderland, SR4 6AD, UK

Tel: +44 (0) 191 565 5348 Fax: +44 (0) 191 564 0002 Email: [sales@tigerfiltration.co.uk](mailto:sales@tigerfiltration.co.uk)

## Tiger Filtration Ltd

### MIKROPOR

Alternative filter elements manufactured by **Tiger Filtration Ltd** to fit into **MIKROPOR** filter housings

## Alternative Filter Elements



Tiger P/No.	Mikropor P/No.	List Price £
MP24 (*)	M24 (*)	47.00
MP48 (*)	M48 (*)	47.00
MP25 (*)	M25 (*)	50.00
MP50 (*)	M50 (*)	50.00
MP100 (*)	M100 (*)	58.00
MP150 (*)	M150 (*)	68.00
MP200 (*)	M200 (*)	73.00
MP250 (*)	M250 (*)	77.00
MP300 (*)	M300 (*)	85.00
MP500 (*)	M500 (*)	95.00
MP600 (*)	M600 (*)	104.00
MP851 (*)	M851 (*)	187.00
MP1210 (*)	M1210 (*)	208.00
MP1510 (*)	M1510 (*)	240.00
MP1810 (*)	M1810 (*)	263.00
MP2210 (*)	M2210 (*)	285.00

(\*) = grade - Example: M24 X order as MP24 M1  
M5 replaces P (5 Micron)  
M1 replaces X (1 Micron)  
MX replaces Y (0.01 Micron & 0.01mg/m<sup>3</sup> oil removal)  
AC replaces A (Activated Carbon)



### Tiger Filtration Ltd

Unit 3, Rivergreen Industry Centre, Pallion, Sunderland, SR4 6AD, UK  
Tel: +44 (0) 191 565 5348 Fax: +44 (0) 191 564 0002 Email: sales@tigerfiltration.co.uk



## Tiger Filtration Ltd

## Alternative Filter Elements

### M.T.A.

Alternative filter elements manufactured by **Tiger Filtration Ltd** to fit into **M.T.A.** filter housings



Tiger P/No.	MTA P/No.	List Price £
MT6050 (*)	6050 (*)	23.00
MT7050 (*)	7050 (*)	26.00
MT14050 (*)	14050 (*)	35.00
MT12075 (*)	12075 (*)	45.00
MT22075 (*)	22075 (*)	60.00
MT32075 (*)	32075 (*)	74.00
MT50075 (*)	50075 (*)	93.00
MT51090 (*)	51090 (*)	127.00
MT76090 (*)	76090 (*)	150.00
MT75140 (*)	75140 (*)	238.00

(\*) = grade - Example: 6050M order as MT6050 M1  
 M3 replaces P (3 Micron)  
 M1 replaces M (1 Micron)  
 MX replaces S (0.01 Micron & 0.01mg/m<sup>3</sup> oil removal)  
 AC replaces A (Activated Carbon)

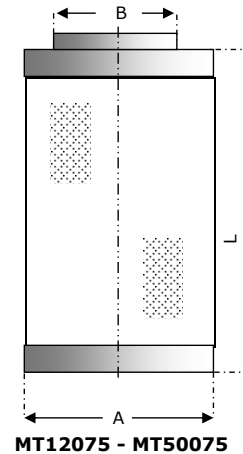

MT12075 - MT50075

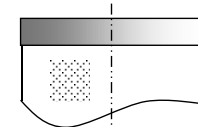

MT6050 - MT14050

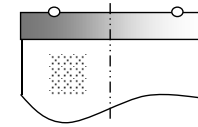

MT51090 - MT75140

Tiger P/No.	A (mm)	B (mm)	L (mm)
MT6050	51	24 (ID)	61
MT7050	51	24 (ID)	72
MT14050	51	24 (ID)	140
MT12075	75	63	119
MT22075	75	63	219
MT32075	75	63	319
MT50075	75	63	500
MT51090	91	67 (ID)	509
MT76090	91	67 (ID)	766
MT75140	140	100 (ID)	751



### Tiger Filtration Ltd

Unit 3, Rivergreen Industry Centre, Pallion, Sunderland, SR4 6AD, UK  
 Tel: +44 (0) 191 565 5348 Fax: +44 (0) 191 564 0002 Email: sales@tigerfiltration.co.uk

## Tiger Filtration Ltd

### Omega

Alternative filter elements manufactured by **Tiger Filtration Ltd** to fit into **Omega** filter housings

## Alternative Filter Elements



Tiger P/No.	Omega P/No.	List Price £
OM6050 (*)	06050 (*)	35.00
OM7050 (*)	07050 (*)	44.00
OM14050 (*)	14050 (*)	54.00
OM12075 (*)	12075 (*)	68.00
OM22075 (*)	22075 (*)	92.00
OM32075 (*)	32075 (*)	111.00
OM50075 (*)	50075 (*)	140.00
OM51090 (*)	51090 (*)	172.00
OM76090 (*)	76090 (*)	196.00
OM51140 (*)	51140 (*)	247.00
OM75140 (*)	75140 (*)	282.00

(\*) = grade - Example: 06050 R order as OM6050 M1  
M3 replaces P (3 Micron)  
M1 replaces R (1 Micron)  
M0 replaces M (0.1 Micron)  
MX replaces S (0.01 Micron & 0.01mg/m<sup>3</sup> oil removal)  
AC replaces A (Activated Carbon)



### Tiger Filtration Ltd

Unit 3, Rivergreen Industry Centre, Pallion, Sunderland, SR4 6AD, UK  
Tel: +44 (0) 191 565 5348 Fax: +44 (0) 191 564 0002 Email: sales@tigerfiltration.co.uk

## Tiger Filtration Ltd

### OMI

Alternative filter elements manufactured by **Tiger Filtration Ltd** to fit into **OMI** filter housings

## Alternative Filter Elements



Tiger P/No.	OMI P/No.	List Price £
OM005 (*)	04E 0030 (*)	25.00
OM010 (*)	04E 0060 (*)	29.00
OM018 (*)	04E 0108 (*)	38.00
OM030 (*)	04E 0180 (*)	41.00
OM034 (*)	04E 0204 (*)	44.00
OM050 (*)	04E 0300 (*)	52.00
OM072 (*)	04E 0432 (*)	58.00
OM095 (*)	04E 0570 (*)	77.00
OM125 (*)	04E 0750 (*)	100.00
OM165 (*)	04E 0990 (*)	122.00
OM190 (*)	04E 1140 (*)	131.00
OM220 (*)	04E 1320 (*)	171.00

(\*) = grade - Example: 04E 0030 PF order as OM005 M1  
M10 replaces DF (10 Micron)  
M5 replaces QF (5 Micron)  
M1 replaces PF (1 Micron)  
MX replaces HF (0.01 Micron & 0.01mg/m<sup>3</sup> oil removal)  
AC replaces CF (Activated Carbon)



### Tiger Filtration Ltd

Unit 3, Rivergreen Industry Centre, Pallion, Sunderland, SR4 6AD, UK  
Tel: +44 (0) 191 565 5348 Fax: +44 (0) 191 564 0002 Email: sales@tigerfiltration.co.uk

## Tiger Filtration Ltd

### OMI-Previous

Alternative filter elements manufactured by **Tiger Filtration Ltd** to fit into **OMI** filter housings

## Alternative Filter Elements



Grade M5 (QF) 5 Micron

Tiger P/No.	OMI P/No.	List Price £
OM005 M5	040 F050	25.00
OM010 M5	040 F051	29.00
OM018 M5	040 F052	38.00
OM034 M5	040 F053	44.00
OM050 M5	040 F054	52.00
OM095 M5	040 F055	77.00
OM125 M5	040 F056	100.00
OM125 M5	040 F057	100.00
OM165 M5	040 F058	122.00
OM220 M5	040 F059	171.00

Grade M1 (PF) 1 Micron

Tiger P/No.	OMI P/No.	List Price £
OM005 M1	041 F150	25.00
OM010 M1	041 F151	29.00
OM018 M1	041 F152	38.00
OM034 M1	041 F153	44.00
OM050 M1	041 F154	52.00
OM095 M1	041 F155	77.00
OM125 M1	041 F156	100.00
OM125 M1	041 F157	100.00
OM165 M1	041 F158	122.00
OM220 M1	041 F159	171.00

Grade M0 (HF) 0.1 Micron

Tiger P/No.	OMI P/No.	List Price £
OM005 M0	042 F250	25.00
OM010 M0	042 F251	29.00
OM018 M0	042 F252	38.00
OM034 M0	042 F253	44.00
OM050 M0	042 F254	52.00
OM095 M0	042 F255	77.00
OM125 M0	042 F256	100.00
OM125 M0	042 F257	100.00
OM165 M0	042 F258	122.00
OM220 M0	042 F259	171.00

Grade AC (CF) Activated Carbon

Tiger P/No.	OMI P/No.	List Price £
OM005 AC	043 F350	25.00
OM010 AC	043 F351	29.00
OM018 AC	043 F352	38.00
OM034 AC	043 F353	44.00
OM050 AC	043 F354	52.00
OM095 AC	043 F355	77.00
OM125 AC	043 F356	100.00
OM125 AC	043 F357	100.00
OM165 AC	043 F358	122.00
OM220 AC	043 F359	171.00



### Tiger Filtration Ltd

Unit 3, Rivergreen Industry Centre, Pallion, Sunderland, SR4 6AD, UK

Tel: +44 (0) 191 565 5348 Fax: +44 (0) 191 564 0002 Email: sales@tigerfiltration.co.uk

## Tiger Filtration Ltd

### Pall/PPC

Alternative filter elements manufactured by **Tiger Filtration Ltd** to fit into **Pall/PPC** filter housings

## Alternative Filter Elements



Tiger P/No.	Pall P/No.	List Price £
P3A13 M3	PPFK3A13 AF	POA
P3A13 MX	PPFK3A13 SU	POA
P3A13 HT	PPFK3A13 HT	POA
P3A13 AC	PPFK3A13 A	POA

Tiger P/No.	Pall P/No.	List Price £
P2A10 M3	PPFK2A10 AF	POA
P2A10 MX	PPFK2A10 SU	POA
P2A10 HT	PPFK2A10 HT	POA
P2A10 AC	PPFK2A10 A	POA



### Tiger Filtration Ltd

Unit 3, Rivergreen Industry Centre, Pallion, Sunderland, SR4 6AD, UK

Tel: +44 (0) 191 565 5348 Fax: +44 (0) 191 564 0002 Email: [sales@tigerfiltration.co.uk](mailto:sales@tigerfiltration.co.uk)

## Tiger Filtration Ltd

### Pneumatech

Alternative filter elements manufactured by **Tiger Filtration Ltd** to fit into **Pneumatech** filter housings

## Alternative Filter Elements



Grade M3 3 Micron

Tiger P/No.	Pn-tech P/No.	List Price £
PT01 M3	1624-5000-01	35.00
PT06 M3	1624-5000-06	44.00
PT11 M3	1624-5000-11	54.00
PT16 M3	1624-5000-16	68.00
PT21 M3	1624-5000-21	92.00
PT26 M3	1624-5000-26	111.00
PT31 M3	1624-5000-31	140.00
PT36 M3	1624-5000-36	172.00
PT41 M3	1624-5000-41	196.00
PT46 M3	1624-5000-46	247.00
PT51 M3	1624-5000-51	282.00

Grade M1 1 Micron

Tiger P/No.	Pn-tech P/No.	List Price £
PT05 M1	1624-5000-05	35.00
PT10 M1	1624-5000-10	44.00
PT15 M1	1624-5000-15	54.00
PT20 M1	1624-5000-20	68.00
PT25 M1	1624-5000-25	92.00
PT30 M1	1624-5000-30	111.00
PT35 M1	1624-5000-35	140.00
PT40 M1	1624-5000-40	172.00
PT45 M1	1624-5000-45	196.00
PT50 M1	1624-5000-50	247.00
PT55 M1	1624-5000-55	282.00

Grade M0 0.1 Micron

Tiger P/No.	Pn-tech P/No.	List Price £
PT04 M0	1624-5000-04	35.00
PT09 M0	1624-5000-09	44.00
PT14 M0	1624-5000-14	54.00
PT19 M0	1624-5000-19	68.00
PT24 M0	1624-5000-24	92.00
PT29 M0	1624-5000-29	111.00
PT34 M0	1624-5000-34	140.00
PT39 M0	1624-5000-39	172.00
PT44 M0	1624-5000-44	196.00
PT49 M0	1624-5000-49	247.00
PT54 M0	1624-5000-54	282.00

Grade MX 0.01 Micron

Tiger P/No.	Pn-tech P/No.	List Price £
PT02 MX	1624-5000-02	35.00
PT07 MX	1624-5000-07	44.00
PT12 MX	1624-5000-12	54.00
PT17 MX	1624-5000-17	68.00
PT22 MX	1624-5000-22	92.00
PT27 MX	1624-5000-27	111.00
PT32 MX	1624-5000-32	140.00
PT37 MX	1624-5000-37	172.00
PT42 MX	1624-5000-42	196.00
PT47 MX	1624-5000-47	247.00
PT52 MX	1624-5000-52	282.00

Grade AC Activated Carbon

Tiger P/No.	Pn-tech P/No.	List Price £
PT03 AC	1624-5000-03	35.00
PT08 AC	1624-5000-08	44.00
PT13 AC	1624-5000-13	54.00
PT18 AC	1624-5000-18	68.00
PT23 AC	1624-5000-23	92.00
PT28 AC	1624-5000-28	111.00
PT33 AC	1624-5000-33	140.00
PT38 AC	1624-5000-38	172.00
PT43 AC	1624-5000-43	196.00
PT48 AC	1624-5000-48	247.00
PT53 AC	1624-5000-53	282.00



### Tiger Filtration Ltd

Unit 3, Rivergreen Industry Centre, Pallion, Sunderland, SR4 6AD, UK

Tel: +44 (0) 191 565 5348 Fax: +44 (0) 191 564 0002 Email: sales@tigerfiltration.co.uk

## Tiger Filtration Ltd

### Puska

Alternative filter elements manufactured by **Tiger Filtration Ltd** to fit into **Puska** filter housings

## Alternative Filter Elements



Tiger P/No.	Puska P/No.	List Price £
PK10 (*)	(*) 10	35.00
PK13 (*)	(*) 13	44.00
PK20 (*)	(*) 20	54.00
PK33 (*)	(*) 33	68.00
PK60 (*)	(*) 60	92.00
PK85 (*)	(*) 85	111.00
PK130 (*)	(*) 130	140.00
PK170 (*)	(*) 170	172.00
PK250 (*)	(*) 250	196.00

(\*) = grade - Example: PMO10 order as PK10 M1  
M3 replaces PRO (3 Micron)  
M1 replaces PMO (1 Micron)  
MX replaces PMM (0.01 Micron)  
AC replaces PCA (Activated Carbon)



### Tiger Filtration Ltd

Unit 3, Rivergreen Industry Centre, Pallion, Sunderland, SR4 6AD, UK  
Tel: +44 (0) 191 565 5348 Fax: +44 (0) 191 564 0002 Email: sales@tigerfiltration.co.uk

## Tiger Filtration Ltd

### PVR

Alternative air/oil separator elements manufactured by **Tiger Filtration Ltd** to fit into **PVR** vacuum pumps

## Alternative Filter Elements



Tiger P/No.	PVR P/No.	Pump Model	List Price £
PV2556	002556	EV45/65	34.00
PV3957	003957	EV105	55.00
PV4391	004391	EV160	41.00
PV3604	003604	EV205/300	48.00
PV5099	005099	EV650	65.00

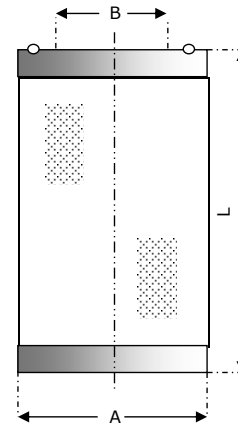

Tiger P/No.	A (mm)	B (mm)	L (mm)
PV2556	74	35	252
PV3957	100	60	260
PV4391	74	35	300
PV3604	80	45	362
PV5099	80	45	528



### Tiger Filtration Ltd

Unit 3, Rivergreen Industry Centre, Pallion, Sunderland, SR4 6AD, UK

Tel: +44 (0) 191 565 5348 Fax: +44 (0) 191 564 0002 Email: [sales@tigerfiltration.co.uk](mailto:sales@tigerfiltration.co.uk)



## Tiger Filtration Ltd

### Rietschle

Alternative filter elements manufactured by **Tiger Filtration Ltd** to fit into **Rietschle** vacuum pumps

## Alternative Filter Elements



Tiger P/No.	Rietschle P/No.	Previous Model	List Price £
RT399	731-399	730-946	39.00
RT311	731-311	731-023	41.00
RT400	731-400	730-936	39.00
RT401	731-401	730-937	50.00

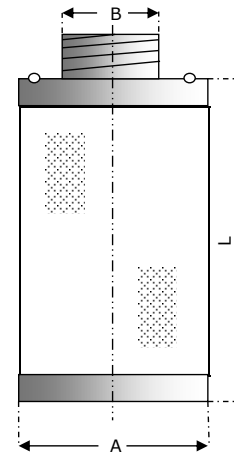

Tiger P/No.	A (mm)	B (mm)	L (mm)
RT399	56	M24	78
RT311	56	M24	123
RT400	72	M33	83
RT401	80	M45	127



### Tiger Filtration Ltd

Unit 3, Rivergreen Industry Centre, Pallion, Sunderland, SR4 6AD, UK

Tel: +44 (0) 191 565 5348 Fax: +44 (0) 191 564 0002 Email: sales@tigerfiltration.co.uk

## Tiger Filtration Ltd

### Sotras

Alternative filter elements manufactured by **Tiger Filtration Ltd** to fit into **Sotras** filter housings

## Alternative Filter Elements



Grade M3(Pre-Filter) 3 Micron

Tiger P/No.	Sotras P/No.	List Price £
ST9017 M3	SM 9017	23.00
ST9021 M3	SM 9021	26.00
ST9025 M3	SM 9025	35.00
ST9029 M3	SM 9029	45.00
ST9033 M3	SM 9033	60.00
ST9037 M3	SM 9037	74.00
ST9041 M3	SM 9041	93.00
ST9045 M3	SM 9045	127.00
ST9049 M3	SM 9049	150.00
ST9053 M3	SM 9053	238.00

Grade M0(Fine Filter) 0.1 Micron

Tiger P/No.	Sotras P/No.	List Price £
ST9018 M0	SM 9018	23.00
ST9022 M0	SM 9022	26.00
ST9026 M0	SM 9026	35.00
ST9030 M0	SM 9030	45.00
ST9034 M0	SM 9034	60.00
ST9038 M0	SM 9038	74.00
ST9042 M0	SM 9042	93.00
ST9046 M0	SM 9046	127.00
ST9050 M0	SM 9050	150.00
ST9054 M0	SM 9054	238.00

Grade MX (Micro Filter) 0.01 Micron

Tiger P/No.	Sotras P/No.	List Price £
ST9019 MX	SM 9019	23.00
ST9023 MX	SM 9023	26.00
ST9027 MX	SM 9027	35.00
ST9031 MX	SM 9031	45.00
ST9035 MX	SM 9035	60.00
ST9039 MX	SM 9039	74.00
ST9043 MX	SM 9043	93.00
ST9047 MX	SM 9047	127.00
ST9051 MX	SM 9051	150.00
ST9055 MX	SM 9055	238.00

Grade AC (Activated Carbon) Activated Carbon

Tiger P/No.	Sotras P/No.	List Price £
ST9020 AC	SM 9020	23.00
ST9024 AC	SM 9024	26.00
ST9028 AC	SM 9028	35.00
ST9032 AC	SM 9032	45.00
ST9036 AC	SM 9036	60.00
ST9040 AC	SM 9040	74.00
ST9044 AC	SM 9044	93.00
ST9048 AC	SM 9048	127.00
ST9052 AC	SM 9052	150.00
ST9056 AC	SM 9056	238.00



### Tiger Filtration Ltd

Unit 3, Rivergreen Industry Centre, Pallion, Sunderland, SR4 6AD, UK

Tel: +44 (0) 191 565 5348 Fax: +44 (0) 191 564 0002 Email: sales@tigerfiltration.co.uk

## Tiger Filtration Ltd

### Sullair

Alternative filter elements manufactured by **Tiger Filtration Ltd** to fit into **Sullair** filter housings

## Alternative Filter Elements



Grade M1 1 Micron

Tiger P/No.	Sullair P/No.	List Price £
SU423 M1	250024-423	38.00
SU424 M1	250024-424	63.00
SU425 M1	250024-425	74.00
SU426 M1	250024-426	91.00
SU427 M1	250024-427	119.00
SU428 M1	250024-428	143.00
SU429 M1	250024-429	206.00
SU644 M1	250024-644	243.00
SU430 M1	250024-430	329.00

Grade MX 0.01 Micron

Tiger P/No.	Sullair P/No.	List Price £
SU431 MX	250024-431	38.00
SU432 MX	250024-432	63.00
SU433 MX	250024-433	74.00
SU434 MX	250024-434	91.00
SU435 MX	250024-435	119.00
SU436 MX	250024-436	143.00
SU437 MX	250024-437	206.00
SU655 MX	250024-655	243.00
SU438 MX	250024-438	329.00

Grade AC Activated Carbon

Tiger P/No.	Sullair P/No.	List Price £
SU443 AC	250024-443	38.00
SU444 AC	250024-444	63.00
SU445 AC	250024-445	74.00
SU446 AC	250024-446	91.00
SU447 AC	250024-447	119.00
SU439 AC	250024-439	143.00
SU440 AC	250024-440	206.00
SU646 AC	250024-646	243.00
SU441 AC	250024-441	329.00



### Tiger Filtration Ltd

Unit 3, Rivergreen Industry Centre, Pallion, Sunderland, SR4 6AD, UK

Tel: +44 (0) 191 565 5348 Fax: +44 (0) 191 564 0002 Email: sales@tigerfiltration.co.uk

## Tiger Filtration Ltd

### Tepro

Alternative air/oil separator elements manufactured by **Tiger Filtration Ltd** to fit into **Tepro** vacuum pumps

## Alternative Filter Elements



Tiger P/No.	Tepro P/No.	Pump Model	List Price £
TP713	FPS70x130	AT21/21A	24.00
TP716	FPS70x160	AT21B/40B	27.00
TP725	FPS70x250	AT63B/100B	36.00

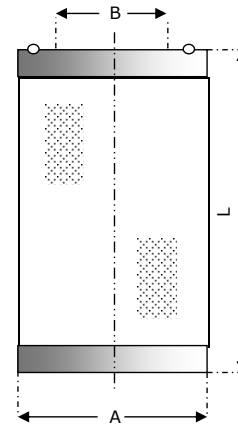

Tiger P/No.	A (mm)	B (mm)	L (mm)
TP713	70	29 (ID)	130
TP716	70	29 (ID)	160
TP725	70	29 (ID)	250



### Tiger Filtration Ltd

Unit 3, Rivergreen Industry Centre, Pallion, Sunderland, SR4 6AD, UK

Tel: +44 (0) 191 565 5348 Fax: +44 (0) 191 564 0002 Email: [sales@tigerfiltration.co.uk](mailto:sales@tigerfiltration.co.uk)

## Tiger Filtration Ltd

### Ultrafilter (90 Series)

Alternative filter elements manufactured by **Tiger Filtration Ltd** to fit into **Ultrafilter (90 Series)** filter housings

#### Standard Elements

Tiger P/no.	UF P/No.	List Price £
UF0205 (*)	(*) 02/05	44.00
UF0210 (*)	(*) 02/10	45.00
UF0305 (*)	(*) 03/05	49.00
UF0310 (*)	(*) 03/10	55.00
UF0410 (*)	(*) 04/10	61.00
UF0420 (*)	(*) 04/20	72.00
UF0520 (*)	(*) 05/20	81.00
UF0525 (*)	(*) 05/25	92.00
UF0725 (*)	(*) 07/25	107.00
UF0730 (*)	(*) 07/30	127.00
UF1030 (*)	(*) 10/30	158.00
UF1530 (*)	(*) 15/30	176.00
UF2030 (*)	(*) 20/30	206.00
UF3030 (*)	(*) 30/30	280.00
UF3050 (*)	(*) 30/50	413.00

(\*) = grade - Example: FF02/05 order as UF0205 M1  
 M25 replaces V-PE (25 Micron)  
 M1 replaces FF (1 Micron)  
 M0 replaces MF (0.1 Micron & oil removal)  
 MX replaces SMF (0.01 Micron & 0.01mg/m<sup>3</sup> oil removal)  
 AC replaces AK (Activated Carbon)

## Alternative Filter Elements



#### HT/CR or HT/NX Range

Tiger P/no.	UF P/No.	List Price £
UFHT0205 (*)	(*) 02/05	POA
UFHT0305 (*)	(*) 03/05	POA
UFHT0310 (*)	(*) 03/10	POA
UFHT0410 (*)	(*) 04/10	POA
UFHT0420 (*)	(*) 04/20	POA
UFHT0520 (*)	(*) 05/20	POA
UFHT0525 (*)	(*) 05/25	POA
UFHT0725 (*)	(*) 07/25	POA
UFHT0730 (*)	(*) 07/30	POA
UFHT1030 (*)	(*) 10/30	POA
UFHT1530 (*)	(*) 15/30	POA
UFHT2030 (*)	(*) 20/30	POA
UFHT3030 (*)	(*) 30/30	POA
UFHT3050 (*)	(*) 30/50	POA

(\*) = grade - Example: FF02/05 order as UFHT0205 M1  
 M1 replaces FF (1 Micron)  
 M0 replaces MF (0.1 Micron & oil removal)  
 MX replaces SMF (0.01 Micron & 0.01mg/m<sup>3</sup> oil removal)



### Tiger Filtration Ltd

Unit 3, Rivergreen Industry Centre, Pallion, Sunderland, SR4 6AD, UK  
 Tel: +44 (0) 191 565 5348 Fax: +44 (0) 191 564 0002 Email: sales@tigerfiltration.co.uk

## Tiger Filtration Ltd

### Ultrafilter (80 Series)

Alternative filter elements manufactured by **Tiger Filtration Ltd** to fit into **Ultrafilter (80 Series)** filter housings

#### Standard Elements

Tiger P/No.	UF P/No.	List Price £
UF425 (*)	(*) 4/2.5	91.00
UF525 (*)	(*) 5/2.5	92.00
UF53 (*)	(*) 5/3	123.00
UF103 (*)	(*) 10/3	156.00
UF153 (*)	(*) 15/3	176.00
UF203 (*)	(*) 20/3	203.00
UF303 (*)	(*) 30/3	253.00
UF305 (*)	(*) 30/5	392.00

(\*) = grade - Example: FF4/2.5 order as UF425 M1  
M25 replaces V (25 Micron)  
M1 replaces FF (1 Micron)  
M0 replaces MF (0.1 Micron & oil removal)  
MX replaces SMF (0.01 Micron & 0.01mg/m<sup>3</sup> oil removal)  
AC replaces AK (Activated Carbon)

#### HT/CR or HT/NX Range

Tiger P/No.	UF P/No.	List Price £
UFHT 103 (*)	(*) 10/3	POA
UFHT 153 (*)	(*) 15/3	POA
UFHT 203 (*)	(*) 20/3	POA
UFHT 303 (*)	(*) 30/3	POA
UFHT 305 (*)	(*) 30/5	POA

(\*) = grade - Example: FF103 order as UFHT103 M1  
M1 replaces FF (1 Micron)  
M0 replaces MF (0.1 Micron & oil removal)  
MX replaces SMF (0.01 Micron & 0.01mg/m<sup>3</sup> oil removal)

## Alternative Filter Elements



### Tiger Filtration Ltd

Unit 3, Rivergreen Industry Centre, Pallion, Sunderland, SR4 6AD, UK  
Tel: +44 (0) 191 565 5348 Fax: +44 (0) 191 564 0002 Email: sales@tigerfiltration.co.uk

## Tiger Filtration Ltd

### Van Air Systems

Alternative filter elements manufactured by **Tiger Filtration Ltd** to fit into **Van Air Systems** filter housings

A Range

Tiger P/No.	Van Air P/No.	List Price £
VA200-15 (*)	E200-15 (*)	37.00
VA200-25 (*)	E200-25 (*)	52.00
VA200-55 (*)	E200-55 (*)	62.00
VA200-85 (*)	E200-85 (*)	90.00
VA200-100 (*)	E200-100 (*)	107.00
VA200-150 (*)	E200-150 (*)	122.00
VA200-265 (*)	E200-265 (*)	136.00
VA200-350 (*)	E200-350 (*)	164.00
VA200-400 (*)	E200-400 (*)	164.00
VA200-500 (*)	E200-500 (*)	203.00
VA200-600 (*)	E200-600 (*)	241.00
VA200-800 (*)	E200-800 (*)	317.00
VA200-1000 (*)	E200-1000 (*)	375.00

(\*) = grade - Example: E200-15 B order as VA200-15 M1  
 M25 replaces AA (25 Micron)  
 M5 replaces A (5 Micron)  
 M1 replaces B (1 Micron)  
 MX replaces C (0.01 micron)  
 AC replaces D (Activated Carbon)

## Alternative Filter Elements



Previous

Tiger P/No.	Van Air P/No.	List Price £
VA100-15 (*)	E100-15 (*)	50.00
VA100-30 (*)	E100-30 (*)	62.00
VA100-50 (*)	E100-50 (*)	69.00
VA100-75 (*)	E100-75 (*)	90.00
VA100-100 (*)	E100-100 (*)	106.00
VA100-150 (*)	E100-150 (*)	122.00
VA100-225 (*)	E100-225 (*)	136.00
VA100-350 (*)	E100-350 (*)	164.00
VA100-500 (*)	E100-500 (*)	200.00
VA100-750 (*)	E100-750 (*)	318.00
VA100-1000 (*)	E100-1000 (*)	375.00
VA101/102-500 (*)	E101/102-500 (*)	196.00
VA101/102-625 (*)	E101/102-625 (*)	212.00

(\*) = grade - Example: E100-15 B order as VA100-15 M1  
 M25 replaces AA (25 Micron)  
 M5 replaces A (5 Micron)  
 M1 replaces B (1 Micron)  
 MX replaces C (0.01 micron)  
 AC replaces D (Activated Carbon)



### Tiger Filtration Ltd

Unit 3, Rivergreen Industry Centre, Pallion, Sunderland, SR4 6AD, UK  
 Tel: +44 (0) 191 565 5348 Fax: +44 (0) 191 564 0002 Email: sales@tigerfiltration.co.uk

## Tiger Filtration Ltd

### Walker

Alternative filter elements manufactured by **Tiger Filtration Ltd** to fit into **Walker** filter housings

Tiger P/No.	Walker P/No.	List Price £
WF361 (*)	E361 (*)	37.00
WF381 ACC	E381 AC	28.00
WF371 (*)	E371 (*)	52.00
WF511 (*)	E511 (*)	62.00
WF711 (*)	E711 (*)	90.00
WF811 (*)	E811 (*)	107.00
WF731 (*)	E731 (*)	122.00
WF821 (*)	E821 (*)	136.00
WF831 (*)	E831 (*)	164.00
WF851 (*)	E851 (*)	203.00
WF1251 (*)	E1251 (*)	241.00
WF1261 (*)	E1261 (*)	317.00
WF1281 (*)	E1281 (*)	375.00
WF139 (*)	E139 (*)	419.00
WF88 (*)	E88 (*)	226.00

(\*) = grade - Example: E361 X1 order as WF361 M1  
M25 replaces X25 (25 Micron)  
M5 replaces X5 (5 Micron)  
M1 replaces X1 (1 Micron)  
MX replaces XA (0.01 micron)  
AC replaces AC (Activated Carbon)

#### Medical Vacuum Elements

Tiger P/No.	Walker P/No.	List Price £
WF511 MV	E511 MV	62.00
WF521 MV	E521 MV	81.00
WF811 MV	E811 MV	107.00
WF821 MV	E821 MV	136.00
WF831 MV	E831 MV	164.00
WF851 MV	E851 MV	203.00
WF1261 MV	E1261 MV	317.00
WF1281 MV	E1281 MV	375.00
WF139 MV	E139 MV	546.00
WF88 MV	E88 MV	248.00



### Tiger Filtration Ltd

Unit 3, Rivergreen Industry Centre, Pallion, Sunderland, SR4 6AD, UK

Tel: +44 (0) 191 565 5348 Fax: +44 (0) 191 564 0002 Email: sales@tigerfiltration.co.uk

## Alternative Filter Elements



#### High Pressure Elements - 50 Barg

Tiger P/No.	Walker P/No.	List Price £
WF50 (*)	E50 (*)	50.00
WF51 (*)	E51 (*)	62.00
WF52 (*)	E52 (*)	69.00
WF715 (*)	E715 (*)	90.00
WF730 (*)	E730 (*)	122.00
WF830 (*)	E830 (*)	136.00
WF86 (*)	E86 (*)	196.00

#### High Pressure Elements - 100 Barg

Tiger P/No.	Walker P/No.	List Price £
WFHP371 (*)	HP371 (*)	85.00
WFHP381 (*)	HP381 (*)	104.00
WFHP420 (*)	HP420 (*)	125.00
WFHP710 (*)	HP710 (*)	152.00
WFHP730 (*)	HP730 (*)	178.00
WFHP830 (*)	HP830 (*)	195.00
WFHP860 (*)	HP860 (*)	269.00

#### High Pressure Elements - 350 Barg

Tiger P/No.	Walker P/No.	List Price £
WFHP261 (*)	HP261 (*)	63.00
WFHP371 (*)	HP371 (*)	85.00
WFHP410 (*)	HP410 (*)	105.00
WFHP420 (*)	HP420 (*)	125.00
WFHP710 (*)	HP710 (*)	152.00
WFHP730 (*)	HP730 (*)	178.00

(\*) = grade - Example: E50 X1 order as WF50 M1  
M25 replaces X25 (25 Micron)  
M5 replaces X5 (5 Micron)  
M1 replaces X1 (1 Micron)  
MX replaces XA (0.01 micron)  
AC replaces AC (Activated Carbon)



## Tiger Filtration Ltd

### Walker - Alloy High Pressure Elements

Alternative filter elements manufactured by **Tiger Filtration Ltd** to fit into **Walker** filter housings

20 Bar Alloy High Pressure

Tiger P/No.	Walker P/No.	List Price £
WF1003 (*)	E1003 (*)	52.00
WF1503 (*)	E1503 (*)	52.00
WF2005 (*)	E2005 (*)	78.00
WF2505 (*)	E2505 (*)	112.00
WF2008 (*)	E2008 (*)	112.00
WF2508 (*)	E2508 (*)	137.00
WF2512 (*)	E2512 (*)	161.00
WF2712 (*)	E2712 (*)	182.00
WF3012 (*)	E3012 (*)	200.00
WF3020 (*)	E3020 (*)	236.00
WF5020 (*)	E5020 (*)	290.00
WF5024 (*)	E5024 (*)	383.00
WF5030 (*)	E5030 (*)	432.00

(\*) = grade - Example: E1003 X1 order as WF1003 M1  
 M25 replaces X25 (25 Micron)  
 M5 replaces X5 (5 Micron)  
 M1 replaces X1 (1 Micron)  
 MX replaces XA (0.01 micron)  
 AC replaces AC (Activated Carbon)

## Alternative Filter Elements



50 Bar Alloy High Pressure

Tiger P/No.	Walker P/No.	List Price £
WFHP1535 (*)	HP1535 (*)	62.00
WFHP1550 (*)	HP1550 (*)	67.00
WFHP2040 (*)	HP2040 (*)	79.00
WFHP2540 (*)	HP2540 (*)	103.00
WFHP2080 (*)	HP2080 (*)	141.00
WFHP2580 (*)	HP2580 (*)	166.00
WFHP2512 (*)	HP2512 (*)	228.00
WFHP2520 (*)	HP2520 (*)	293.00

(\*) = grade - Example: HP1535 X1 order as WFHP1535 M1  
 M25 replaces X25 (25 Micron)  
 M5 replaces X5 (5 Micron)  
 M1 replaces X1 (1 Micron)  
 MX replaces XA (0.01 micron)  
 AC replaces AC (Activated Carbon)



### Tiger Filtration Ltd

Unit 3, Rivergreen Industry Centre, Pallion, Sunderland, SR4 6AD, UK  
 Tel: +44 (0) 191 565 5348 Fax: +44 (0) 191 564 0002 Email: sales@tigerfiltration.co.uk

## Tiger Filtration Ltd

### Walker - Medical Sterile Elements - A Range and Previous

Alternative filter elements manufactured by **Tiger Filtration Ltd** to fit into **Walker** filter housings

Medical Sterile A Range

Tiger P/No.	Walker P/No.	List Price £
WF361 SR	E361 SR	75.00
WF371 SR	E371 SR	91.00
WF511 SR	E511 SR	100.00
WF711 SR	E711 SR	133.00
WF811 SR	E811 SR	149.00
WF731 SR	E731 SR	164.00
WF821 SR	E821 SR	205.00
WF831 SR	E831 SR	237.00
WF851 SR	E851 SR	345.00
WF1251 SR	E1251 SR	454.00
WF1261 SR	E1261 SR	529.00
WF1281 SR	E1281 SR	662.00

## Alternative Filter Elements



Medical Sterile - Previous

Tiger P/No.	Walker P/No.	List Price £
WF50 SR	E50 SR	79.00
WF51 SR	E51 SR	94.00
WF52 SR	E52 SR	104.00
WF71 SR	E71 SR	137.00
WF81 SR	E81 SR	155.00
WF73 SR	E73 SR	171.00
WF83 SR	E83 SR	184.00
WF831 SR	E831 SR	237.00
WF123 SR	E123 SR	353.00
WF125 SR	E125 SR	468.00
WF134 SR	E134 SR	353.00
WF135 SR	E135 SR	473.00
WF127 SR	E127 SR	546.00
WF128 SR	E128 SR	678.00



### Tiger Filtration Ltd

Unit 3, Rivergreen Industry Centre, Pallion, Sunderland, SR4 6AD, UK

Tel: +44 (0) 191 565 5348 Fax: +44 (0) 191 564 0002 Email: sales@tigerfiltration.co.uk

## Tiger Filtration Ltd

### Walker - Previous

Alternative filter elements manufactured by **Tiger Filtration Ltd** to fit into **Walker** filter housings

Tiger P/No.	Walker P/No.	List Price £
WF50 (*)	E50 (*)	50.00
WF51 (*)	E51 (*)	62.00
WF52 (*)	E52 (*)	69.00
WF71 (*)	E71 (*)	90.00
WF81 (*)	E81 (*)	106.00
WF73 (*)	E73 (*)	122.00
WF83 (*)	E83 (*)	136.00
WF103 (*)	E103 (*)	164.00
WF123 (*)	E123 (*)	200.00
WF125 (*)	E125 (*)	241.00
WF134 (*)	E134 (*)	203.00
WF135 (*)	E135 (*)	241.00
WF127 (*)	E127 (*)	318.00
WF128 (*)	E128 (*)	365.00
WF830 (*)	E830 (*)	136.00
WF86 (*)	E86 (*)	196.00
WF87 (*)	E87 (*)	212.00
WF137 (*)	E137 (*)	303.00
WF138 (*)	E138 (*)	383.00

(\*) = grade - Example: E50 X1 order as WF50 M1  
 M25 replaces X25 (25 Micron)  
 M5 replaces X5 (5 Micron)  
 M1 replaces X1 (1 Micron)  
 MX replaces XA (0.01 micron)  
 AC replaces AC (Activated Carbon)

## Alternative Filter Elements



### Medical Vacuum Elements

Tiger P/No.	Walker P/No.	List Price £
WF27 MV	E27 MV	48.00
WF37 MV	E37 MV	58.00
WF57 MV	E57 MV	73.00
WF81 MV	E81 MV	103.00
WF83 MV	E83 MV	155.00
WF103 MV	E103 MV	185.00
WF133 MV	E133 MV	226.00
WF137 MV	E137 MV	289.00
WF138 MV	E138 MV	323.00

### High Pressure Elements

Tiger P/No.	Walker P/No.	List Price £
WFHP260 (*)	HP260 (*)	63.00
WFHP310 (*)	HP310 (*)	85.00

(\*) = grade - Example: HP260 X1 order as WFHP260 M1  
 M25 replaces X25 (25 Micron)  
 M5 replaces X5 (5 Micron)  
 M1 replaces X1 (1 Micron)  
 MX replaces XA (0.01 micron)  
 AC replaces AC (Activated Carbon)



### Tiger Filtration Ltd

Unit 3, Rivergreen Industry Centre, Pallion, Sunderland, SR4 6AD, UK  
 Tel: +44 (0) 191 565 5348 Fax: +44 (0) 191 564 0002 Email: sales@tigerfiltration.co.uk

## Tiger Filtration Ltd

## Alternative Filter Elements

### Worthington Creyssensac

Alternative filter elements manufactured by **Tiger Filtration Ltd** to fit into **Worthington Creyssensac** filter housings



<b>Tiger P/No.</b>	<b>Worthington P/No.</b>	<b>List Price £</b>
WC60 (*)	D60 (*)	35.00
WC80 (*)	D80 (*)	44.00
WC120 (*)	D120 (*)	54.00
WC200 (*)	D200 (*)	68.00
WC340 (*)	D340 (*)	92.00
WC510 (*)	D510 (*)	111.00
WC800 (*)	D800 (*)	140.00
WC1000 (*)	D1000 (*)	172.00
WC1500 (*)	D1500 (*)	196.00
WC2400 (*)	D2400 (*)	282.00

(\*) = grade - Example: D60 D order as WC60 M1

M3 replaces P (3 Micron)

M1 replaces D (1 Micron)

M0 replaces M (0.1 Micron)

MX replaces S (0.01 Micron)

AC replaces A (Activated Carbon)



### Tiger Filtration Ltd

Unit 3, Rivergreen Industry Centre, Pallion, Sunderland, SR4 6AD, UK

Tel: +44 (0) 191 565 5348 Fax: +44 (0) 191 564 0002 Email: [sales@tigerfiltration.co.uk](mailto:sales@tigerfiltration.co.uk)

## Tiger Filtration Ltd

### Zander (Parker)

Alternative filter elements manufactured by **Tiger Filtration Ltd** to fit into **Zander (Parker)** filter housings

## Alternative Filter Elements



<b>Tiger P/No.</b>	<b>Zander P/No.</b>	<b>List Price £</b>
ZA103 (*)	1030 (*)	56.00
ZA105 (*)	1050 (*)	66.00
ZA107 (*)	1070 (*)	78.00
ZA114 (*)	1140 (*)	96.00
ZA201 (*)	2010 (*)	127.00
ZA202 (*)	2020 (*)	163.00
ZA203 (*)	2030 (*)	203.00
ZA205 (*)	2050 (*)	261.00
ZA305 (*)	3050 (*)	307.00
ZA307 (*)	3075 (*)	358.00
ZA506 (*)	5060 (*)	493.00
ZA507 (*)	5075 (*)	595.00

(\*) = grade - Example: 1050 Z order as ZA105 M1

M5 replaces V (5 Micron)

M1 replaces Z (1 Micron)

M0 replaces Y (0.1 Micron)

MX replaces X (0.01 Micron & 0.01mg/m<sup>3</sup> oil removal)

AC replaces A (Activated Carbon)



### Tiger Filtration Ltd

Unit 3, Rivergreen Industry Centre, Pallion, Sunderland, SR4 6AD, UK

Tel: +44 (0) 191 565 5348 Fax: +44 (0) 191 564 0002 Email: sales@tigerfiltration.co.uk

## Tiger Filtration Ltd

### Zeks

Alternative filter elements manufactured by **Tiger Filtration Ltd** to fit into **Zeks** filter housings

## Alternative Filter Elements



Tiger P/No.	Zeks P/No.	List Price £
ZK15 (*)	E15 (*)	29.00
ZK30 (*)	E30 (*)	30.00
ZK32 (*)	E32 (*)	31.00
ZK65 (*)	E65 (*)	39.00
ZK80 (*)	E80 (*)	54.00
ZK100 (*)	E100 (*)	69.00
ZK150 (*)	E150 (*)	80.00
ZK250 (*)	E250 (*)	140.00
ZK300 (*)	E300 (*)	150.00
ZK500 (*)	E500 (*)	188.00
ZK650 (*)	E650 (*)	198.00
ZK1000 (*)	E1000 (*)	258.00
ZK1250 (*)	E1250 (*)	283.00
ZK1600 (*)	E1600 (*)	378.00

(\*) = grade - Example: E15 G order as ZK15 M1

M5 replaces P (5 Micron)

M1 replaces G (1 Micron)

MX replaces H (0.01 Micron & 0.01mg/m<sup>3</sup> oil removal)

AC replaces A (Activated Carbon)



### Tiger Filtration Ltd

Unit 3, Rivergreen Industry Centre, Pallion, Sunderland, SR4 6AD, UK

Tel: +44 (0) 191 565 5348 Fax: +44 (0) 191 564 0002 Email: [sales@tigerfiltration.co.uk](mailto:sales@tigerfiltration.co.uk)