



The Only Real Alternative 2017 Price List (£)

Rev 1 - 010117



Tiger Filtration Ltd - The Only Real Alternative

Contents

	Page		Page		Page
Abac	1	Gardner Denver	25	Sullair	49
AFE	2	Hankison	26	Tepro	50
ALMiG	3	Hi-Line	27	Ultrafilter - 90 Series	51
Atlas Copco - Present	4	Hiross	28	Ultrafilter - 80 Series	52
Atlas Copco - Previous	5	HPC	29	Van Air Systems	53
Atlas Copco - Previous	6	Hydrovane	30	Walker Filtration - Present	54
Becker	7	Hydrovane - Separators	31	Walker Filtration - Present	55
BOGE	8	Ingersoll Rand	32	Walker Filtration - Present	56
Busch	9	Kaeser	33	Walker Filtration - Previous	57
Ceccato	10	Leybold	34	Worthington Creyssenac	58
Compair - Present	11	Mark	35	Zander	59
Compair - Previous	12	Mattei	36	Zeks	60
CTA	13	Mattei - Separators	37		
Deltech	14	MiKROPOR	38		
Denco	15	MTA	39		
Domnick Hunter - Present	16	Omega	40		
Domnick Hunter - Previous	17	OMI - Present	41		
Domnick Hunter - Previous	18	OMI - Previous	42		
DVP	19	Pall/PPC	43		
Ecoair	20	Pneumatech	44		
Edwards	21	Puska	45		
Filterworld	22	PVR	46		
Friulair - FT	23	Rietschle	47		
Friulair - FL	24	Sotras	48		

Alternative Filter Elements



Quality Products from Tiger Filtration Ltd - Our range of Alternative Elements are designed and manufactured to perform "as good if not better" than the original equipment. All the materials used in the manufacture of these elements are sourced from recognised suppliers to the industry. We are so confident in our products that we offer a full 12 months "money back" guarantee if you are not happy with the performance. When you buy a product from **Tiger Filtration Ltd** you get a promise from the Managing Director that the elements are "as good if not better" than the original.



Tiger Filtration Ltd

Unit 3, Rivergreen Industry Centre, Pallion, Sunderland, SR4 6AD, UK
 Tel: +44 (0) 191 565 5348 Fax: +44 (0) 191 564 0002 Email: sales@tigerfiltration.co.uk



Tiger Filtration Ltd

Abac

Alternative filter elements manufactured by **Tiger Filtration Ltd** to fit into **Abac** filter housings

Alternative Filter Elements



Tiger P/No.	Abac P/No.	List Price £
AB60 (*)	(*) 60	24.00
AB80 (*)	(*) 80	27.00
AB120 (*)	(*) 120	36.00
AB200 (*)	(*) 200	46.00
AB340 (*)	(*) 340	62.00
AB510 (*)	(*) 510	76.00
AB800 (*)	(*) 800	96.00
AB1000 (*)	(*) 1000	131.00
AB1500 (*)	(*) 1500	155.00
AB2400 (*)	(*) 2400	245.00

(*) = grade - Example: APFC60 order as AB60 M1

M3 replaces AQFC (3 Micron)

M1 replaces APFC (1 Micron)

M0 replaces AEFC (0.1 Micron)

MX replaces AHFC (0.01 Micron & 0.01mg/m³ oil removal)

AC replaces ACFC (Activated Carbon)



Tiger Filtration Ltd

Unit 3, Rivergreen Industry Centre, Pallion, Sunderland, SR4 6AD, UK

Tel: +44 (0) 191 565 5348 Fax: +44 (0) 191 564 0002 Email: sales@tigerfiltration.co.uk

Tiger Filtration Ltd

Alternative Filter Elements

AFE

Alternative filter elements manufactured by **Tiger Filtration Ltd** to fit into **AFE** filter housings



Tiger P/No.	AFE P/No.	List Price £
AF10 (*)	EA10 (*)	47.00
AF15 (*)	EA15 (*)	57.00
AF20 (*)	EA20 (*)	65.00
AF30 (*)	EA30 (*)	82.00
AF55 (*)	EA55 (*)	108.00
AF95 (*)	EA95 (*)	140.00
AF150 (*)	EA150 (*)	180.00
AF220 (*)	EA220 (*)	222.00
AF290 (*)	EA290 (*)	296.00
AF430 (*)	EA430 (*)	350.00
AF625 (*)	EA625 (*)	494.00
AF775 (*)	EA775 (*)	647.00

(*) = grade - Example: EA10U order as AF10 M1
 M3 replaces P (3 Micron)
 M1 replaces U (1 Micron)
 MX replaces H (0.01 Micron & 0.01mg/m³ oil removal)
 AC replaces C (Activated Carbon)

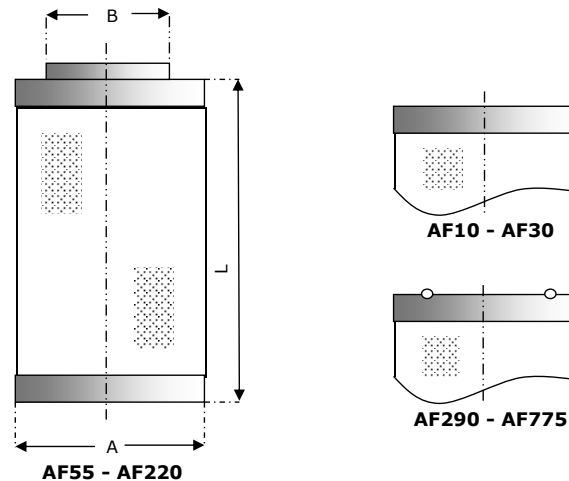

Tiger P/No.	A (mm)	B (mm)	L (mm)
AF10 (*)	51	24 (ID)	50
AF15 (*)	51	24 (ID)	61
AF20 (*)	51	24 (ID)	72
AF30 (*)	51	24 (ID)	140
AF55 (*)	75	63	110
AF95 (*)	75	63	210
AF150 (*)	75	63	310
AF220 (*)	75	63	500
AF290 (*)	91	67 (ID)	509
AF430 (*)	91	67 (ID)	766
AF625 (*)	140	100 (ID)	616
AF775 (*)	140	100 (ID)	751



Tiger Filtration Ltd

Unit 3, Rivergreen Industry Centre, Pallion, Sunderland, SR4 6AD, UK
 Tel: +44 (0) 191 565 5348 Fax: +44 (0) 191 564 0002 Email: sales@tigerfiltration.co.uk

Tiger Filtration Ltd

ALMiG

Alternative filter elements manufactured by **Tiger Filtration Ltd** to fit into **ALMiG** filter housings

Alternative Filter Elements



Tiger P/No.	Almig P/No.	List Price £
AL30 (*)	(*) 30	26.00
AL60 (*)	(*) 60	30.00
AL108 (*)	(*) 108	39.00
AL180 (*)	(*) 180	42.00
AL204 (*)	(*) 204	45.00
AL300 (*)	(*) 300	54.00
AL432 (*)	(*) 432	60.00
AL570 (*)	(*) 570	79.00
AL750 (*)	(*) 750	103.00
AL990 (*)	(*) 990	126.00
AL1140 (*)	(*) 1140	135.00
AL1320 (*)	(*) 1320	176.00

(*) = grade - Example: AFM30 order as AL30 M1

M5 replaces AFP (3 Micron)

M1 replaces AFM (1 Micron)

MX replaces AFS (0.01 Micron & 0.01mg/m³ oil removal)

AC replaces AFC (Activated Carbon)



Tiger Filtration Ltd

Unit 3, Rivergreen Industry Centre, Pallion, Sunderland, SR4 6AD, UK

Tel: +44 (0) 191 565 5348 Fax: +44 (0) 191 564 0002 Email: sales@tigerfiltration.co.uk

Tiger Filtration Ltd

Atlas Copco

Alternative filter elements manufactured by **Tiger Filtration Ltd** to fit into **Atlas Copco** filter housings

Alternative Filter Elements



Grade M1 (DDp) 1 Micron

Tiger P/No.	AC P/No.	List Price £
AC9 M1	2901 0520 00	73.00
AC17 M1	2901 0613 00	96.00
AC32 M1	2901 0526 00	136.00
AC44 M1	2901 0529 00	156.00
AC60 M1	2901 0532 00	190.00
AC120 M1	2901 0535 00	229.00
AC150 M1	2901 0538 00	249.00
AC175 M1	2901 0541 00	267.00
AC260 M1	2901 0544 00	353.00
AC280 M1	2901 0544 00	353.00
AC390 M1	2906 7000 00	418.00
AC520 M1	2906 7003 00	479.00
AC-AX M1	1617 7073 03	391.00

Grade M1 (DD) 1 Micron

Tiger P/No.	AC P/No.	List Price £
AC9 M1	2901 0520 00	73.00
AC17 M1	2901 0613 00	96.00
AC32 M1	2901 0526 00	136.00
AC44 M1	2901 0529 00	156.00
AC60 M1	2901 0532 00	190.00
AC120 M1	2901 0535 00	229.00
AC150 M1	2901 0538 00	249.00
AC175 M1	2901 0541 00	267.00
AC260 M1	2901 0544 00	353.00
AC280 M1	2901 0544 00	353.00
AC390 M1	2906 7000 00	418.00
AC520 M1	2906 7003 00	479.00
AC-AX M1	1617 7073 03	391.00

Grade MX (PD) 0.01 Micron

Tiger P/No.	AC P/No.	List Price £
AC9 MX	2901 0521 00	73.00
AC17 MX	2901 0524 00	96.00
AC32 MX	2901 0527 00	136.00
AC44 MX	2901 0530 00	156.00
AC60 MX	2901 0533 00	190.00
AC120 MX	2901 0536 00	229.00
AC150 MX	2901 0539 00	249.00
AC175 MX	2901 0542 00	267.00
AC260 MX	2901 0545 00	353.00
AC280 MX	2901 0545 00	353.00
AC390 MX	2906 7001 00	418.00
AC520 MX	2906 7004 00	479.00
AC-AX MX	1617 7073 01	391.00

Grade AC (QD) Activated Carbon

Tiger P/No.	AC P/No.	List Price £
AC9 AC	2901 614 00	73.00
AC17 AC	2901 0525 00	96.00
AC32 AC	2901 0528 00	136.00
AC44 AC	2901 0531 00	156.00
AC60 AC	2901 0534 00	190.00
AC120 AC	2901 0537 00	229.00
AC150 AC	2901 0540 00	249.00
AC175 AC	2901 0543 00	267.00
AC260 AC	2901 0546 00	353.00
AC280 AC	2901 0546 00	353.00
AC390 AC	2906 7002 00	418.00
AC520 AC	2906 7005 00	479.00
AC-AX AC	1617 7073 02	391.00



Tiger Filtration Ltd

Unit 3, Rivergreen Industry Centre, Pallion, Sunderland, SR4 6AD, UK

Tel: +44 (0) 191 565 5348 Fax: +44 (0) 191 564 0002 Email: sales@tigerfiltration.co.uk

Tiger Filtration Ltd

Atlas Copco - Previous

Alternative filter elements manufactured by **Tiger Filtration Ltd** to fit into **Atlas Copco** filter housings

Alternative Filter Elements



Grade M1 (DD) 1 Micron

Tiger P/No.	AC P/No.	List Price £
AC190 M1	2901-0190-00	52.00
AC191 M1	2901-0191-00	82.00
AC234 M1	2901-0234-00	94.00
AC192 M1	2901-0192-00	116.00
AC193 M1	2901-0193-00	150.00
AC194 M1	2901-0194-00	184.00
AC213 M1	2906-0213-00	402.00
AC212 M1	2906-0212-00	306.00

Grade MX (PD) 0.01 Micron

Tiger P/No.	AC P/No.	List Price £
AC195 MX	2901-0195-00	52.00
AC196 MX	2901-0196-00	82.00
AC233 MX	2901-0233-00	94.00
AC197 MX	2901-0197-00	116.00
AC198 MX	2901-0198-00	150.00
AC199 MX	2901-0199-00	184.00
AC215 MX	2906-0215-00	402.00
AC214 MX	2906-0214-00	306.00

Grade AC (QD) Activated Carbon

Tiger P/No.	AC P/No.	List Price £
AC206 AC	2901-0206-00	248.00
AC201 ACC	2901-0201-00	30.00
AC203 ACC	2901-0203-00	48.00
AC235 ACC	2901-0235-00	95.00
AC205 ACC	2901-0205-00	123.00
AC217 AC	2901-0217-00	402.00
AC202 ACC	2901-0202-00	33.00
AC204 ACC	2901-0204-00	68.00
AC216 AC	2906-0216-00	306.00

Grade M1 (DD) 1 Micron

Tiger P/No.	AC P/No.	List Price £
AC625502 M1	1202-6255-02	52.00
AC625702 M1	1202-6257-02	82.00
AC625704 M1	1202-6257-04	94.00
AC625902 M1	1202-6259-02	116.00
AC625904 M1	1202-6259-04	150.00
AC626202 M1	1202-6262-02	184.00
AC857302 M1	1202-8573-02	306.00
AC627302 M1	1202-6273-02	402.00
AC626204 M1	1202-6262-04	241.00

Grade MX (PD) 0.01 Micron

Tiger P/No.	AC P/No.	List Price £
AC625501 MX	1202-6255-01	52.00
AC625701 MX	1202-6257-01	82.00
AC625703 MX	1202-6257-03	94.00
AC625901 MX	1202-6259-01	116.00
AC625903 MX	1202-6259-03	150.00
AC626201 MX	1202-6262-01	184.00
AC857301 MX	1202-8573-01	306.00
AC627301 MX	1202-6273-01	402.00
AC626203 MX	1202-6262-03	241.00

Grade AC (QD) Activated Carbon

Tiger P/No.	AC P/No.	List Price £
AC626400 ACC	1202-6264-00	30.00
AC628101 ACC	1202-6281-01	33.00
AC626801 ACC	1202-6268-01	48.00
AC628102 ACC	1202-6281-02	68.00
AC626802 ACC	1202-6268-02	95.00
AC626803 ACC	1202-6268-03	123.00
AC626301 AC	1202-6263-01	184.00
AC857200 AC	1202-8572-00	306.00
AC627400 AC	1202-6274-00	402.00
AC626302 AC	1202-6263-02	241.00

ACC = AC Element For Duplex Housing



Tiger Filtration Ltd

Unit 3, Rivergreen Industry Centre, Pallion, Sunderland, SR4 6AD, UK
 Tel: +44 (0) 191 565 5348 Fax: +44 (0) 191 564 0002 Email: sales@tigerfiltration.co.uk

Tiger Filtration Ltd

Atlas Copco - Previous

Alternative filter elements manufactured by **Tiger Filtration Ltd** to fit into **Atlas Copco** filter housings

Alternative Filter Elements



Grade M5 (UFD) 5 Micron

Tiger P/No.	AC P/No.	List Price £
AC925 M5	9703-1925	99.00
AC926 M5	9703-1926	113.00
AC927 M5	9703-1927	146.00
AC928 M5	9703-1928	192.00
AC929 M5	9703-1929	218.00
AC930 M5	9703-1930	285.00
AC931 M5	9703-1931	378.00

Grade M1 (UDD) 1 Micron

Tiger P/No.	AC P/No.	List Price £
AC420 M1	9703-1420	99.00
AC421 M1	9703-1421	113.00
AC422 M1	9703-1422	146.00
AC423 M1	9703-1423	192.00
AC424 M1	9703-1424	218.00
AC425 M1	9703-1425	285.00
AC426 M1	9703-1426	378.00

Grade MX (UPD) 0.01 Micron

Tiger P/No.	AC P/No.	List Price £
AC442 MX	9703-1442	99.00
AC443 MX	9703-1443	113.00
AC444 MX	9703-1444	146.00
AC445 MX	9703-1445	192.00
AC446 MX	9703-1446	218.00
AC447 MX	9703-1447	285.00
AC448 MX	9703-1448	378.00

Grade AC (AC) Activated Carbon

Tiger P/No.	AC P/No.	List Price £
AC431 AC	9703-1431	99.00
AC432 AC	9703-1432	113.00
AC433 AC	9703-1433	146.00
AC434 AC	9703-1434	192.00
AC435 AC	9703-1435	218.00
AC436 AC	9703-1436	285.00
AC437 AC	9703-1437	378.00



Tiger Filtration Ltd

Unit 3, Rivergreen Industry Centre, Pallion, Sunderland, SR4 6AD, UK

Tel: +44 (0) 191 565 5348 Fax: +44 (0) 191 564 0002 Email: sales@tigerfiltration.co.uk

Tiger Filtration Ltd

Becker

Alternative air/oil separator elements manufactured by **Tiger Filtration Ltd** to fit into **Becker** vacuum pumps

Alternative Filter Elements



Tiger P/No.	Becker P/No.	List Price £
BK100 MF	6540100	26.00
BK402 MF	965402	59.00
BK403 MF	965403	70.00
BK404 MF	965404	31.00
BK406 MF	965406	72.00
BK409 MF	965409	48.00
BK410 MF	965410	180.00
BK411 MF	965411	219.00
BK412 MF	965412	48.00
BK413 MF	965413	35.00
BK414 MF	965414	34.00
BK415 MF	965415	45.00
BK416 MF	965416	43.00



Tiger Filtration Ltd

Unit 3, Rivergreen Industry Centre, Pallion, Sunderland, SR4 6AD, UK
Tel: +44 (0) 191 565 5348 Fax: +44 (0) 191 564 0002 Email: sales@tigerfiltration.co.uk

Tiger Filtration Ltd

BOGE

Alternative filter elements manufactured by **Tiger Filtration Ltd** to fit into **BOGE** filter housings

Alternative Filter Elements



Tiger P/No.	BOGE P/No.	List Price £
BG5 (*)	1/5 (*)	63.00
BG10 (*)	1/10 (*)	76.00
BG12 (*)	1/12 (*)	88.00
BG20 (*)	1/20 (*)	109.00
BG30 (*)	1/30 (*)	143.00
BG50 (*)	1/50 (*)	184.00
BG80 (*)	1/80 (*)	229.00
BG120 (*)	1/120 (*)	296.00
BG160 (*)	1/160 (*)	349.00
BG250 (*)	1/250 (*)	408.00
BG400 (*)	1/400 (*)	677.00

(*) = grade - Example: 1/5 V order as BG5 M3
M3 replaces V (3 Micron)
MX replaces FP (0.01 Micron)
AC replaces A (Activated Carbon)



Tiger Filtration Ltd

Unit 3, Rivergreen Industry Centre, Pallion, Sunderland, SR4 6AD, UK
Tel: +44 (0) 191 565 5348 Fax: +44 (0) 191 564 0002 Email: sales@tigerfiltration.co.uk

Tiger Filtration Ltd

Busch

Alternative air/oil separator elements manufactured by **Tiger Filtration Ltd** to fit into **Busch** vacuum pumps

Alternative Filter Elements



Grade MF			Without Silencer
Tiger P/No.	Busch P/No.	O. D. Length	List Price £
BU101 MF	532-101	52mm/230mm	39.00
BU151 MF	532-151	35mm/56mm	18.00
BU216 MF	532-216	54mm/120mm	26.00
BU222 MF	532-222	54mm/200mm	26.00
BU221 MF	532-221	72mm/130mm	26.00
BU301 MF	532-301	52mm/230mm	39.00
BU302 MF	532-302	72mm/250mm	32.00
BU303 MF	532-303	72mm/375mm	49.00
BU304 MF	532-304	72mm/500mm	65.00

Grade MFS			With Silencer
Tiger P/No.	Busch P/No.	O. D. Length	List Price £
BU510 MFS	532-510	72mm/130mm	31.00
BU509 MFS	532-509	72mm/250mm	37.00
BU508 MFS	532-508	72mm/375mm	55.00
BU507 MFS	532-507	72mm/500mm	71.00
BU512 MFS	532-512	72mm/208mm	34.00

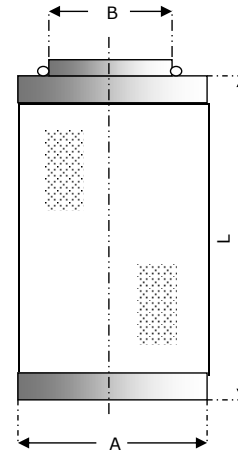

Tiger P/No.	A (mm)	B (mm)	L (mm)
BU101 MF	52	M22 thread	230
BU151 MF	35	3/8 BSP	56
BU216 MF	54	29	120
BU222 MF	54	29	200
BU221 MF	72	35	130
BU301 MF	52	M22 thread	230
BU302 MF	72	35	250
BU303 MF	72	35	375
BU304 MF	72	35	500
BU510 MFS	72	35	130
BU509 MFS	72	35	250
BU508 MFS	72	35	375
BU507 MFS	72	35	500
BU512 MFS	72	35	208



Tiger Filtration Ltd

Unit 3, Rivergreen Industry Centre, Pallion, Sunderland, SR4 6AD, UK
 Tel: +44 (0) 191 565 5348 Fax: +44 (0) 191 564 0002 Email: sales@tigerfiltration.co.uk

Tiger Filtration Ltd

Ceccato

Alternative filter elements manufactured by **Tiger Filtration Ltd** to fit into **Ceccato** filter housings

Alternative Filter Elements



Tiger P/No.	Ceccato P/No.	List Price £
CE10 (*)	10 (*)	36.00
CE13 (*)	13 (*)	45.00
CE20 (*)	20 (*)	56.00
CE33 (*)	33 (*)	70.00
CE60 (*)	60 (*)	95.00
CE85 (*)	85 (*)	114.00
CE130 (*)	130 (*)	144.00
CE170 (*)	170 (*)	177.00
CE250 (*)	250 (*)	202.00
CE400 (*)	400 (*)	290.00

(*) = grade - Example: 10FPRE order as CE10 M1
M3 replaces FPRO (3 Micron)
M1 replaces FPPE (1 Micron)
M0 replaces FMO (0.1 Micron)
MX replaces FMM (0.01 Micron)
AC replaces FCA (Activated Carbon)



Tiger Filtration Ltd

Unit 3, Rivergreen Industry Centre, Pallion, Sunderland, SR4 6AD, UK
Tel: +44 (0) 191 565 5348 Fax: +44 (0) 191 564 0002 Email: sales@tigerfiltration.co.uk

Tiger Filtration Ltd

Compair

Alternative filter elements manufactured by **Tiger Filtration Ltd** to fit into **Compair** filter housings

Alternative Filter Elements



Tiger P/No.	Compair P/No.	List Price £
CP0005 (*)	CE0005 (*)	45.00
CP0010 (*)	CE0010 (*)	70.00
CP0018 (*)	CE0018 (*)	81.00
CP0036 (*)	CE0036 (*)	107.00
CP0087 (*)	CE0087 (*)	137.00
CP0132 (*)	CE0132 (*)	156.00
CP0198 (*)	CE0198 (*)	212.00
CP0258 (*)	CE0258 (*)	284.00
CP0372 (*)	CE0372 (*)	359.00

(*) = grade - Example: CE0005 B order as CP0005 M1
 M25 replaces A (25 Micron)
 M1 replaces B & E (1 Micron)
 MX replaces C (0.01 Micron)
 AC replaces D (Activated Carbon) - Single Stage Filter Housing

Grade ACC	Activated Carbon	Tiger P/No.	Compair P/No.	List Price £
		CP0004 ACC	CE0004 D	33.00
		CP0008 ACC	CE0008 D	36.00
		CP0015 ACC	CE0015 D	49.00
		CP0024 ACC	CE0024 D	68.00
		CP0039 ACC	CE0039 D	119.00
		CP0051 ACC	CE0051 D	150.00

ACC = AC Element For Duplex Housing



Tiger Filtration Ltd

Unit 3, Rivergreen Industry Centre, Pallion, Sunderland, SR4 6AD, UK
 Tel: +44 (0) 191 565 5348 Fax: +44 (0) 191 564 0002 Email: sales@tigerfiltration.co.uk

Tiger Filtration Ltd

Compair - Previous

Alternative filter elements manufactured by **Tiger Filtration Ltd** to fit into **Compair** filter housings

Alternative Filter Elements



Grade M1(GPP) 1 Micron		
Tiger P/No.	Comp P/No.	List Price £
CP21 M1	98245/121	39.00
CP22 M1	98245/122	65.00
CP23 M1	98245/123	76.00
CP25 M1	98245/125	94.00
CP26 M1	98245/126	123.00
CP27 M1	98245/127	147.00
CP28 M1	98245/128	212.00
CP29 M1	98245/129	339.00
CP30 M1	98245/130	250.00

Grade MX(OPF) 0.01 Micron		
Tiger P/No.	Comp P/No.	List Price £
CP41 MX	98245/141	39.00
CP42 MX	98245/142	65.00
CP43 MX	98245/143	76.00
CP45 MX	98245/145	94.00
CP46 MX	98245/146	123.00
CP47 MX	98245/147	147.00
CP48 MX	98245/148	212.00
CP49 MX	98245/149	339.00
CP50 MX	98245/150	250.00

Grade AC(OVR) Activated Carbon		
Tiger P/No.	Comp P/No.	List Price £
CP61 ACC	98245/161	33.00
CP62 ACC	98245/162	36.00
CP63 ACC	98245/163	49.00
CP64 ACC	98245/164	119.00
CP65 ACC	98245/165	68.00
CP66 ACC	98245/166	150.00
CP67 AC	98245/167	147.00
CP68 AC	98245/168	212.00
CP69 AC	98245/169	339.00
CP70 AC	98245/170	250.00

Grade M1(GPP) 1 Micron		
Tiger P/No.	Comp P/No.	List Price £
CP22 M1	98245/21	65.00
CP23 M1	98245/22	76.00
CP25 M1	98245/23	94.00
CP26 M1	98245/25	123.00
CP27 M1	98245/27	147.00
CP28 M1	98245/28	212.00
CP29 M1	98245/29	339.00

Grade MX(OPF) 0.01 Micron		
Tiger P/No.	Comp P/No.	List Price £
CP42 MX	98245/41	65.00
CP43 MX	98245/42	76.00
CP45 MX	98245/43	94.00
CP46 MX	98245/45	123.00
CP47 MX	98245/47	147.00
CP48 MX	98245/48	212.00
CP49 MX	98245/49	339.00

Grade AC(OVR) Activated Carbon		
Tiger P/No.	Comp P/No.	List Price £
CP62 ACC	98245/62	36.00
CP65 ACC	98245/65	68.00
CP67 AC	98245/67	147.00
CP68 AC	98245/68	212.00

ACC = AC Element For Duplex Housing



Tiger Filtration Ltd

Unit 3, Rivergreen Industry Centre, Pallion, Sunderland, SR4 6AD, UK

Tel: +44 (0) 191 565 5348 Fax: +44 (0) 191 564 0002 Email: sales@tigerfiltration.co.uk

Tiger Filtration Ltd

Alternative Filter Elements

C.T.A.

Alternative filter elements manufactured by **Tiger Filtration Ltd** to fit into **C.T.A.** filter housings



Tiger P/No.	CTA P/No.	List Price £
CT5050 (*)	05050 (*)	35.00
CT6050 (*)	06050 (*)	40.00
CT7050 (*)	07050 (*)	47.00
CT14050 (*)	14050 (*)	59.00
CT12075 (*)	12075 (*)	76.00
CT22075 (*)	22075 (*)	98.00
CT32075 (*)	32075 (*)	121.00
CT50075 (*)	50075 (*)	155.00
CT51090 (*)	51090 (*)	187.00
CT76090 (*)	76090 (*)	216.00
CT75140 (*)	75140 (*)	306.00

(*) = grade - Example: 05050 M order as CT5050 M1
 M3 replaces P (3 Micron)
 M1 replaces M (1 Micron)
 MX replaces S (0.01 Micron)
 AC replaces A (Activated Carbon)

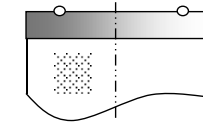
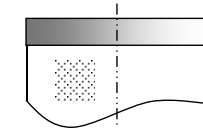
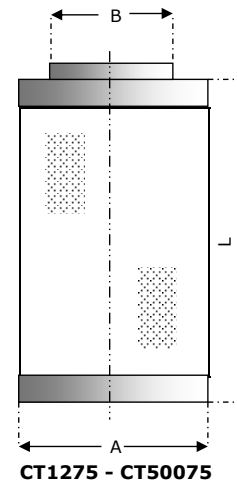

Tiger P/No.	A (mm)	B (mm)	L (mm)
CT5050 (*)	51	24 (ID)	50
CT6050 (*)	51	24 (ID)	61
CT7050 (*)	51	24 (ID)	72
CT14050 (*)	51	24 (ID)	140
CT12075 (*)	75	63	119
CT22075 (*)	75	63	219
CT32075 (*)	75	63	319
CT50075 (*)	75	63	500
CT51090 (*)	91	67 (ID)	509
CT76090 (*)	91	67 (ID)	766
CT75140 (*)	140	100 (ID)	751



Tiger Filtration Ltd

Unit 3, Rivergreen Industry Centre, Pallion, Sunderland, SR4 6AD, UK
 Tel: +44 (0) 191 565 5348 Fax: +44 (0) 191 564 0002 Email: sales@tigerfiltration.co.uk

Tiger Filtration Ltd

Deltech

Alternative filter elements manufactured for **Tiger Filtration Ltd** to fit into **Deltech** filter housings

Alternative Filter Elements



Tiger P/No.	Deltech P/No.	List Price £
DE9 (*)	(*) D 9	POA
DE18 (*)	(*) D 18	POA
DE36 (*)	(*) D 36	POA
DE54 (*)	(*) D 54	POA
DE90 (*)	(*) D 90	POA
DE135 (*)	(*) D 135	POA
DE216 (*)	(*) D 216	POA
DE285 (*)	(*) D 285	POA
DE405 (*)	(*) D 405	POA
DE540 (*)	(*) D 540	POA
DE750 (*)	(*) D 750	POA

(*) = grade - Example: PFD 9 order as DE9 M1
M1 replaces PF & DF (1 Micron)
MX replaces HF (0.01 Micron & 0.01mg/m³ oil removal)
AC replaces CF (Activated Carbon)



Tiger Filtration Ltd

Unit 3, Rivergreen Industry Centre, Pallion, Sunderland, SR4 6AD UK
Tel: +44 (0) 191 565 5348 Fax: +44 (0) 191 564 0002 Email: sales@tigerfiltration.co.uk

Tiger Filtration Ltd

Denco

Alternative filter elements manufactured by **Tiger Filtration Ltd** to fit into **Denco** filter housings

Alternative Filter Elements



Tiger P/No.	Denco P/No.	List Price £
DC12 (*)	(*)DC12	55.00
DC15 (*)	(*)DC15	55.00
DC17 (*)	(*)DC17	63.00
DC22 (*)	(*)DC22	73.00
DC23 (*)	(*)DC23	78.00
DC32 (*)	(*)DC32	83.00
DC42 (*)	(*)DC42	93.00
DC44 (*)	(*)DC44	102.00
DC52 (*)	(*)DC52	112.00
DC62 (*)	(*)DC62	203.00
DC64 (*)	(*)DC64	225.00
DC72 (*)	(*)DC72	260.00
DC82 (*)	(*)DC82	284.00
DC85 (*)	(*)DC85	308.00

(*) = grade - Example: 01DC12 order as DC12 M1

M5 replaces 05 (5 Micron)

M1 replaces 01 (1 Micron)

MX replaces 00 (0.01 Micron & 0.01mg/m³ oil removal)

AC stays as AC (Activated Carbon)



Tiger Filtration Ltd

Unit 3, Rivergreen Industry Centre, Pallion, Sunderland, SR4 6AD, UK

Tel: +44 (0) 191 565 5348 Fax: +44 (0) 191 564 0002 Email: sales@tigerfiltration.co.uk

Tiger Filtration Ltd

Alternative Filter Elements

Domnick Hunter (Parker)

Alternative filter elements manufactured by **Tiger Filtration Ltd** to fit into **Domnick Hunter (Parker)** filter housings



Tiger P/No.	DH P/No.	List Price £
DH009 (*)	K009 (*)	39.00
DH017 (*)	K017 (*)	65.00
DH030 (*)	K030 (*)	76.00
DH058 (*)	K058 (*)	94.00
DH145 (*)	K145 (*)	123.00
DH220 (*)	K220 (*)	147.00
DH330 (*)	K330 (*)	212.00
DH430 (*)	K430 (*)	250.00
DH620 (*)	K620 (*)	339.00

(*) = grade - Example: K009 AO order as DH009 M1
 M25 replaces PF (25 Micron)
 M1 replaces AO (1 Micron)
 MX replaces AA (0.01 Micron & 0.01mg/m³ oil removal)
 MXX replaces AX (0.01 Micron & 0.001mg/m³ oil removal)
 AC replaces ACS (Activated Carbon) - Single Stage Filter Housing

Grade ACC		Activated Carbon	List Price £
Tiger P/No.	DH P/No.		
DH006 ACC	K006 AC		33.00
DH013 ACC	K013 AC		36.00
DH025 ACC	K025 AC		49.00
DH040 ACC	K040 AC		68.00
DH065 ACC	K065 AC		119.00
DH085 ACC	K085 AC		150.00

ACC = AC Element For Duplex Housing



Tiger Filtration Ltd

Unit 3, Rivergreen Industry Centre, Pallion, Sunderland, SR4 6AD, UK
 Tel: +44 (0) 191 565 5348 Fax: +44 (0) 191 564 0002 Email: sales@tigerfiltration.co.uk

Tiger Filtration Ltd

Alternative Filter Elements

Domnick Hunter (Parker) - Previous

Alternative filter elements manufactured by **Tiger Filtration Ltd** to fit into **Domnick Hunter (Parker)** filter housings



Tiger P/No.	DH P/No.	List Price £
DH006 (*)	K006 (*)	39.00
DH013 (*)	K013 (*)	65.00
DH025 (*)	K025 (*)	76.00
DH040 (*)	K040 (*)	94.00
DH085 (*)	K085 (*)	123.00
DH195 (*)	K195 (*)	147.00
DH295 (*)	K295 (*)	212.00
DH400 (*)	K400 (*)	250.00
DH500 (*)	K500 (*)	339.00

(*) = grade - Example: K006 AO order as DH006 M1

M25 replaces PF (25 Micron)

M1 replaces AO (1 Micron)

MX replaces AA (0.01 Micron & 0.01mg/m³ oil removal)

MXX replaces AX (0.01 Micron & 0.001mg/m³ oil removal)

AC replaces ACS with the exception of K006 AC which is replaced by DH006 ACC



Tiger Filtration Ltd

Unit 3, Rivergreen Industry Centre, Pallion, Sunderland, SR4 6AD, UK

Tel: +44 (0) 191 565 5348 Fax: +44 (0) 191 564 0002 Email: sales@tigerfiltration.co.uk

Tiger Filtration Ltd

Domnick Hunter (Parker) - Previous

Alternative filter elements manufactured by **Tiger Filtration Ltd** to fit into **Domnick Hunter (Parker)** filter housings

Alternative Filter Elements



Tiger P/No.	DH P/No.	List Price £
DH007 (*)	E007 (*)	65.00
DH011 (*)	E011 (*)	76.00
DH035 (*)	E035 (*)	94.00
DH060 (*)	E060 (*)	123.00
DH120 (*)	E120 (*)	147.00
DH200 (*)	E200 (*)	212.00
DH250 (*)	E250 (*)	212.00
DH300 (*)	E300 (*)	339.00
DH360 (*)	E360 (*)	339.00

(*) = grade - Example: E007 AO order as DH007 M1
 M25 replaces PF (25 Micron)
 M1 replaces AO (1 Micron)
 MX replaces AA (0.01 Micron & 0.01mg/m³ oil removal)

Tiger P/No.	DH P/No.	List Price £
DH007 (*)	E007 (*)	65.00
DH011 (*)	E011 (*)	76.00
DH035 (*)	E035 (*)	94.00
DH060 (*)	E060 (*)	123.00
DH085 (*)	E085 (*)	123.00
DH120 (*)	E120 (*)	147.00
DH195 (*)	E195 (*)	147.00
DH200 (*)	E200 (*)	212.00
DH250 (*)	E250 (*)	212.00
DH295 (*)	E295 (*)	212.00
DH300 (*)	E300 (*)	339.00
DH360 (*)	E360 (*)	339.00
DH500 (*)	E500 (*)	339.00

(*) = grade - Example: E007 AOTS order as DH007 M1
 M1 replaces AOTS (1 Micron)
 MX replaces AATS (0.01 Micron)

Grade AC		Activated Carbon	
Tiger P/No.	DH P/No.	Tiger P/No.	List Price £
DH011 ACC	ABN 1		48.00
DH011 ACC	E011 AC		48.00
DH060 ACC	E060 AC		68.00
DH120 AC	E120 AC		147.00
DH200 AC	E200 AC		212.00
DH250 AC	E250 AC		212.00
DH300 AC	E300 AC		339.00
DH360 AC	E360 AC		339.00

ACC = AC Element For Duplex Housing



Tiger Filtration Ltd

Unit 3, Rivergreen Industry Centre, Pallion, Sunderland, SR4 6AD, UK
 Tel: +44 (0) 191 565 5348 Fax: +44 (0) 191 564 0002 Email: sales@tigerfiltration.co.uk

Tiger Filtration Ltd

DVP

Alternative air/oil separator elements manufactured by **Tiger Filtration Ltd** to fit into **DVP** vacuum pumps

Alternative Filter Elements



Tiger P/No.	DVP P/No.	Pump Model	List Price £
DV1846	1801046	LB2/3/4/5/6	18.00
DV9033	9001033	LB8, LA12, LC12	27.00
DV9046	9001046	LB18/25, LV25, LA20	29.00
DV1873	1801073	LC25	33.00

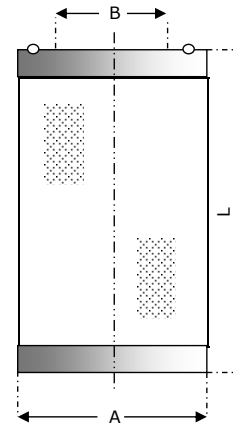

Tiger P/No.	A (mm)	B (mm)	L (mm)
DV1846	34	3/8" BSP	56
DV9033	45	20	62
DV9046	45	20	100
DV1873	45	20	150



Tiger Filtration Ltd

Unit 3, Rivergreen Industry Centre, Pallion, Sunderland, SR4 6AD, UK

Tel: +44 (0) 191 565 5348 Fax: +44 (0) 191 564 0002 Email: sales@tigerfiltration.co.uk

Tiger Filtration Ltd

Ecoair

Alternative filter elements manufactured by **Tiger Filtration Ltd** to fit into **Ecoair** filter housings

Alternative Filter Elements



Tiger P/No.	Ecoair P/No.	List Price £
EC01 (*)	E(*) 01	72.00
EC02 (*)	E(*) 02	84.00
EC03 (*)	E(*) 03	103.00
EC04 (*)	E(*) 04	137.00
EC05 (*)	E(*) 05	176.00
EC06 (*)	E(*) 06	218.00
EC07 (*)	E(*) 07	281.00
EC08 (*)	E(*) 08	332.00
EC09 (*)	E(*) 09	388.00
EC10 (*)	E(*) 10	644.00

(*) = grade - Example: EF 01 order as EC01 M1

M3 replaces V (3 Micron)

M1 replaces F (1 Micron)

MX replaces S (0.01 Micron & 0.01mg/m³ oil removal)

AC replaces A (Activated Carbon)



Tiger Filtration Ltd

Unit 3, Rivergreen Industry Centre, Pallion, Sunderland, SR4 6AD, UK

Tel: +44 (0) 191 565 5348 Fax: +44 (0) 191 564 0002 Email: sales@tigerfiltration.co.uk

Tiger Filtration Ltd

Alternative Filter Elements

Edwards

Alternative air/oil separator elements manufactured by **Tiger Filtration Ltd** to fit into **Edwards** vacuum pumps



Tiger P/No.	Edwards P/No.	List Price £
ED 057	A223 04 057	72.00
ED 020	A223 04 020	81.00
ED 021	A223 04 021	92.00

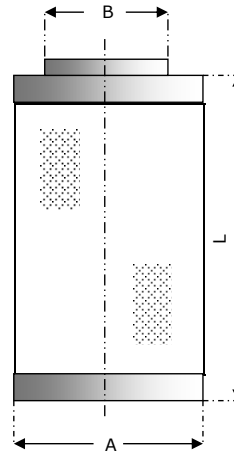

Tiger P/No.	A (mm)	B (mm)	L (mm)
ED057	80	31	173
ED020	80	31	252
ED021	80	55	380



Tiger Filtration Ltd

Unit 3, Rivergreen Industry Centre, Pallion, Sunderland, SR4 6AD, UK

Tel: +44 (0) 191 565 5348 Fax: +44 (0) 191 564 0002 Email: sales@tigerfiltration.co.uk

Tiger Filtration Ltd

Filterworld

Alternative filter elements manufactured by **Tiger Filtration Ltd** to fit into **Filterworld** filter housings

Alternative Filter Elements



Tiger P/No.	FW P/No.	List Price £
FW05 (*)	(*)C05	52.00
FW12 (*)	(*)C12	56.00
FW15 (*)	(*)C15	56.00
FW17 (*)	(*)C17	64.00
FW22 (*)	(*)C22	74.00
FW23 (*)	(*)C23	80.00
FW32 (*)	(*)C32	84.00
FW42 (*)	(*)C42	95.00
FW44 (*)	(*)C44	104.00
FW52 (*)	(*)C52	114.00
FW62 (*)	(*)C62	207.00
FW64 (*)	(*)C64	229.00
FW72 (*)	(*)C72	264.00
FW82 (*)	(*)C82	289.00
FW85 (*)	(*)C85	314.00

(*) = grade - Example: 01C12 order as FW12 M1
M25 replaces 25 (25 Micron)
M5 replaces 05 (5 Micron)
M1 replaces 01 (1 Micron)
MX replaces 00 (0.01 Micron & 0.01mg/m³ oil removal)
AC stays as AC (Activated Carbon)



Tiger Filtration Ltd

Unit 3, Rivergreen Industry Centre, Pallion, Sunderland, SR4 6AD, UK
Tel: +44 (0) 191 565 5348 Fax: +44 (0) 191 564 0002 Email: sales@tigerfiltration.co.uk

Tiger Filtration Ltd

Alternative Filter Elements

Friulair

Alternative filter elements manufactured by **Tiger Filtration Ltd** to fit into **Friulair** filter housings



Tiger P/No.	Friulair P/No.	List Price £
FT008 (*)	T (*) 008	30.00
FT012 (*)	T (*) 012	35.00
FT018 (*)	T (*) 018	44.00
FT030 (*)	T (*) 030	56.00
FT055 (*)	T (*) 055	75.00
FT080 (*)	T (*) 080	90.00
FT120 (*)	T (*) 120	112.00
FT160 (*)	T (*) 160	161.00
FT220 (*)	T (*) 220	241.00
FT250 (*)	T (*) 250	192.00
FT400 (*)	T (*) 400	250.00

(*) = grade - Example: TS008 order as FT008 M1
 M5 replaces P (5 Micron)
 M1 replaces S (1 Micron)
 MX replaces X (0.01 Micron & 0.01mg/m³ oil removal)
 AC replaces Z (Activated Carbon)

N.B. The FT220 (*) element is for multi-candle fabricated vessels

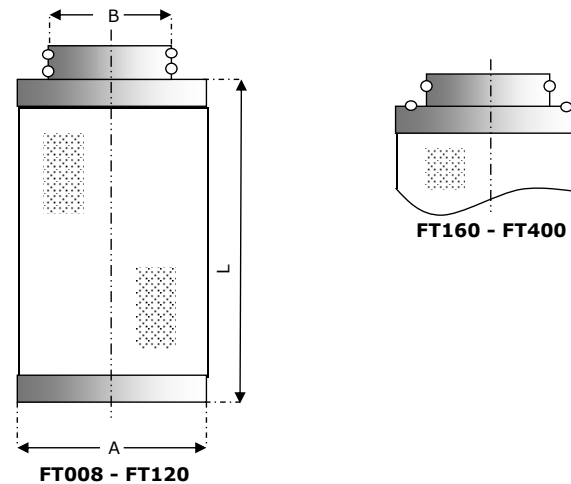

Tiger P/No.	A (mm)	B (mm)	L (mm)
FT008	51	23	61
FT012	51	23	72
FT018	51	23	140
FT030	75	45	119
FT055	75	45	219
FT080	75	45	319
FT120	75	45	497
FT160	91	71	509
FT220	91	71	680
FT250	91	71	766
FT400	140	102	751



Tiger Filtration Ltd

Unit 3, Rivergreen Industry Centre, Pallion, Sunderland, SR4 6AD, UK
 Tel: +44 (0) 191 565 5348 Fax: +44 (0) 191 564 0002 Email: sales@tigerfiltration.co.uk

Tiger Filtration Ltd

Alternative Filter Elements

Friulair - Previous

Alternative filter elements manufactured by **Tiger Filtration Ltd** to fit into **Friulair** filter housings



Tiger P/No.	Friulair P/No.	List Price £
FL008 (*)	L (*) 008	30.00
FL011 (*)	L (*) 011	35.00
FL018 (*)	L (*) 018	44.00
FL031 (*)	L (*) 031	56.00
FL052 (*)	L (*) 052	75.00
FL075 (*)	L (*) 075	90.00
FL118 (*)	L (*) 118	112.00
FL168 (*)	L (*) 168	161.00
FL250 (*)	L (*) 250	192.00
FL400 (*)	L (*) 400	250.00

(*) = grade - Example: LS008 order as FL008 M1
 M5 replaces P (5 Micron)
 M1 replaces S (1 Micron)
 MX replaces X (0.01 Micron & 0.01mg/m³ oil removal)
 AC replaces Z (Activated Carbon)

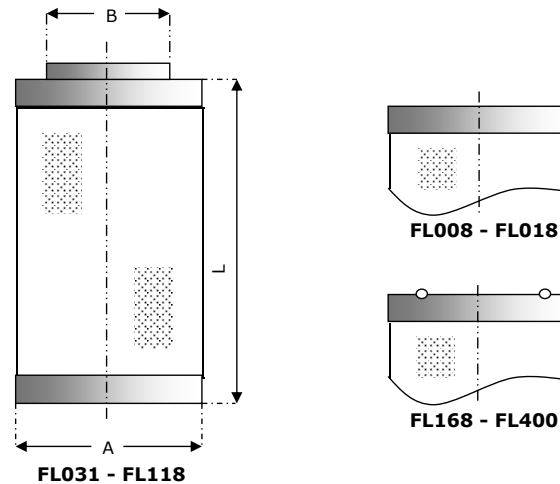

Tiger P/No.	A (mm)	B (mm)	L (mm)
FL008	51	24 (ID)	61
FL011	51	24 (ID)	72
FL018	51	24 (ID)	140
FL031	75	63	119
FL052	75	63	219
FL075	75	63	319
FL118	75	63	497
FL168	91	67 (ID)	509
FL250	91	67 (ID)	766
FL400	140	100 (ID)	751



Tiger Filtration Ltd

Unit 3, Rivergreen Industry Centre, Pallion, Sunderland, SR4 6AD, UK
 Tel: +44 (0) 191 565 5348 Fax: +44 (0) 191 564 0002 Email: sales@tigerfiltration.co.uk

Tiger Filtration Ltd

Alternative Filter Elements

Gardner Denver

Alternative air/oil separator elements manufactured by **Tiger Filtration Ltd** to fit into **Gardner Denver** air compressors



Tiger P/No.	GD P/No.	List Price £
GD03267728	3267728	POA
GD03340028	3340028	POA
GD60455401	60455401	POA
GD60455801	60455801	POA
GD89848519	89848519	POA



Tiger Filtration Ltd

Unit 3, Rivergreen Industry Centre, Pallion, Sunderland, SR4 6AD, UK
Tel: +44 (0) 191 565 5348 Fax: +44 (0) 191 564 0002 Email: sales@tigerfiltration.co.uk

Tiger Filtration Ltd

Hankison

Alternative filter elements manufactured by **Tiger Filtration Ltd** to fit into **Hankison** filter housings

Alternative Filter Elements



Tiger P/No.	Hankison P/No.	List Price £
HK12 (*)	E (*) -12	46.00
HK16 (*)	E (*) - 16	62.00
HK20 (*)	E (*) - 20	81.00
HK24 (*)	E (*) - 24	102.00
HK28 (*)	E (*) - 28	127.00
HK32 (*)	E (*) - 32	142.00
HK36 (*)	E (*) - 36	178.00
HK40 (*)	E (*) - 40	212.00
HK44 (*)	E (*) - 44	238.00
HK52PV (*)	E (*) - 52PV	254.00
HK48 (*)	E (*) - 48	246.00
HK54 (*)	E (*) - 54	246.00

(*) = grade - Example: E7-12 order as HK12 M1

M5 replaces 9 (5 Micron)

M1 replaces 7 (1 Micron)

MX replaces 5 (0.01 Micron & 0.01mg/m³ oil removal)

MXX replaces 3 (0.01 Micron & 0.001mg/m³ oil removal)

AC replaces 1 (Activated Carbon)

N.B. The HK52PV (*) is for multi-candle fabricated vessels



Tiger Filtration Ltd

Unit 3, Rivergreen Industry Centre, Pallion, Sunderland, SR4 6AD, UK

Tel: +44 (0) 191 565 5348 Fax: +44 (0) 191 564 0002 Email: sales@tigerfiltration.co.uk

Tiger Filtration Ltd

Hi-Line

Alternative filter elements manufactured by **Tiger Filtration Ltd** to fit into **Hi-Line** filter housings

Alternative Filter Elements



Tiger P/No.	Hi-Line P/No.	List Price £
HL25 (*)	HE25-(*)	49.00
HL36 (*)	HE36-(*)	60.00
HL50 (*)	HE50-(*)	68.00
HL72 (*)	HE72-(*)	87.00
HL120 (*)	HE120-(*)	113.00
HL210 (*)	HE210-(*)	147.00
HL320 (*)	HE320-(*)	188.00
HL500 (*)	HE500-(*)	235.00
HL630 (*)	HE630-(*)	311.00
HL850 (*)	HE850-(*)	367.00
HL1400 (*)	HE1400-(*)	519.00
HL1700 (*)	HE1700-(*)	680.00

(*) = grade - Example: HE25-3 order as HL25 M1
 M3 replaces 2 (3 Micron)
 M1 replaces 3 (1 Micron)
 MX replaces 4 (0.01 Micron & 0.01mg/m³ oil removal)
 AC replaces 5 (Activated Carbon)

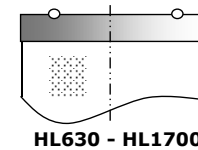
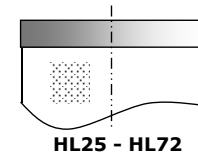
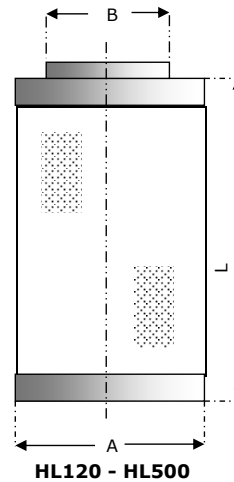

Tiger P/No.	A (mm)	B (mm)	L (mm)
HL25-(*)	51	24(ID)	51
HL36-(*)	51	24(ID)	61
HL50-(*)	51	24(ID)	72
HL72-(*)	51	24(ID)	140
HL120-(*)	75	63	110
HL210-(*)	75	63	210
HL320-(*)	75	63	310
HL500-(*)	75	63	500
HL630-(*)	91	67 (ID)	509
HL850-(*)	91	67 (ID)	766
HL1400-(*)	140	100 (ID)	616
HL1700-(*)	140	100 (ID)	751



Tiger Filtration Ltd

Unit 3, Rivergreen Industry Centre, Pallion, Sunderland, SR4 6AD, UK
 Tel: +44 (0) 191 565 5348 Fax: +44 (0) 191 564 0002 Email: sales@tigerfiltration.co.uk

Tiger Filtration Ltd

Hiross (Parker)

Alternative filter elements manufactured by **Tiger Filtration Ltd** to fit into **Hiross (Parker)** filter housings

Alternative Filter Elements



Tiger P/No.	Hiross P/No.	List Price £
HR005 (*)	005 (*)	44.00
HR010 (*)	002 (*) - 004 (*) - 006 (*) - 010 (*)	44.00
HR016 (*)	007 (*) - 009 (*) - 016 (*)	56.00
HR022 (*)	(*) - 015 (*) - 018 (*) - 020 (*) - 022	63.00
HR030 (*)	024 (*) - 030 (*)	66.00
HR045 (*)	035 (*) - 045 (*)	73.00
HR072 (*)	060 (*) - 062 (*) - 072 (*)	93.00
HR135 (*)	090 (*) - 110 (*) - 122 (*) - 135 (*)	128.00
HR175 (*)	175 (*)	144.00
HR205 (*)	120 (*) - 151 (*) - 205 (*)	164.00
HR180 (*)	150 (*) - 180 (*)	177.00
HR250 (*)	250 (*)	177.00
HR260 (*)	260 (*)	252.00
HR280 (*)	240 (*) - 280 (*)	268.00
HR300 (*)	300 (*)	227.00
HR370 (*)	370 (*)	315.00

(*) = grade - Example: 005P order as HR005 M1

M5 replaces Q (5 Micron)

M1 replaces P (1 Micron)

MX replaces S (0.01 Micron)

AC replaces C (Activated Carbon)

N.B. The HR250 element is for fabricated housing with multiple elements and will be supplied with a 13.5mm dia through hole.



Tiger Filtration Ltd

Unit 3, Rivergreen Industry Centre, Pallion, Sunderland, SR4 6AD, UK

Tel: +44 (0) 191 565 5348 Fax: +44 (0) 191 564 0002 Email: sales@tigerfiltration.co.uk

Tiger Filtration Ltd

HPC

Alternative filter elements manufactured by **Tiger Filtration Ltd** to fit into **HPC** filter housings

Tiger P/No.	HPC P/No.	List Price £
HP009 (*)	K009 (*)	39.00
HP017 (*)	K017 (*)	65.00
HP030 (*)	K030 (*)	76.00
HP058 (*)	K058 (*)	94.00
HP145 (*)	K145 (*)	123.00
HP220 (*)	K220 (*)	147.00
HP330 (*)	K330 (*)	212.00
HP430 (*)	K430 (*)	250.00
HP620 (*)	K620 (*)	339.00

(*) = grade - Example: K009 AO order as HP009 M1
 M1 replaces AO (1 Micron)
 MX replaces AA (0.01 Micron & 0.01mg/m³ oil removal)

Tiger P/No.	HPC P/No.	List Price £
HP006 (*)	K006 (*)	39.00
HP013 (*)	K013 (*)	65.00
HP025 (*)	K025 (*)	76.00
HP040 (*)	K040 (*)	94.00
HP085 (*)	K085 (*)	123.00
HP195 (*)	K195 (*)	147.00
HP295 (*)	K295 (*)	212.00
HP400 (*)	K400 (*)	250.00
HP500 (*)	K500 (*)	339.00

(*) = grade - Example: K006 AO order as HP006 M1
 M1 replaces AO (1 Micron)
 MX replaces AA (0.01 Micron & 0.01mg/m³ oil removal)

Alternative Filter Elements



Grade AC		Activated Carbon	
Tiger P/No.	HPC P/No.	Tiger P/No.	List Price £
HP006 ACC	K006 AC	HP006 ACC	33.00
HP013 ACC	K013 AC	HP013 ACC	36.00
HP025 ACC	K025 AC	HP025 ACC	49.00
HP040 ACC	K040 AC	HP040 ACC	68.00
HP065 ACC	K065 AC	HP065 ACC	119.00
HP085 ACC	K085 AC	HP085 ACC	150.00
HP195 AC	K195 AC	HP195 AC	147.00
HP295 AC	K295 AC	HP295 AC	212.00
HP400 AC	K400 AC	HP400 AC	250.00
HP500 AC	K500 AC	HP500 AC	339.00

ACC = AC Element For Duplex Housing



Tiger Filtration Ltd

Unit 3, Rivergreen Industry Centre, Pallion, Sunderland, SR4 6AD, UK
 Tel: +44 (0) 191 565 5348 Fax: +44 (0) 191 564 0002 Email: sales@tigerfiltration.co.uk

Tiger Filtration Ltd

Hydrovane

Alternative filter elements manufactured by **Tiger Filtration Ltd** to fit into **Hydrovane** filter housings

Alternative Filter Elements



Tiger P/No.	Hydro P/No.	List Price £
HY100 (*)	(*) 100 E	39.00
HY150 (*)	(*) 150 E	65.00
HY200 (*)	(*) 200 E	76.00
HY250 (*)	(*) 250 E	94.00
HY350 (*)	(*) 350 E	123.00
HY450 (*)	(*) 450 E	147.00
HY500 (*)	(*) 500 E	212.00
HY530 (*)	(*) 530 E	250.00
HY600 (*)	(*) 600 E	339.00

(*) = grade - Example: GP100 E order as HY100 M1
 M1 replaces GP & DR (1 Micron)
 MX replaces HE (0.01 Micron & 0.01mg/m³ oil removal)

Grade AC		Activated Carbon
Tiger P/No.	Hydro P/No.	List Price £
HY100 ACC	OR100 E	33.00
HY150 ACC	OR150 E	36.00
HY200 ACC	OR200 E	49.00
HY250 ACC	OR250 E	68.00
HY300 ACC	OR300 E	119.00
HY350 ACC	OR350 E	150.00
HY450 AC	OR450 E	147.00
HY500 AC	OR500 E	212.00
HY530 AC	OR530 E	250.00
HY600 AC	OR600 E	339.00

ACC = Activated Carbon Element For Duplex Housing



Tiger Filtration Ltd

Unit 3, Rivergreen Industry Centre, Pallion, Sunderland, SR4 6AD, UK
 Tel: +44 (0) 191 565 5348 Fax: +44 (0) 191 564 0002 Email: sales@tigerfiltration.co.uk

Tiger Filtration Ltd

Alternative Filter Elements

Hydrovane

Alternative air/oil separator elements manufactured by **Tiger Filtration Ltd** to fit into **Hydrovane** air compressors



Tiger P/No.	Hydro P/No.	List Price £
HY52022	52022	32.00
HY3415	3415	32.00
HY3407	3407	32.00
HY52471	52471	32.00
HY57029	57029	32.00
HY59177	59177	34.00
HY70166	70166	22.00
HY70539	70539	34.00
HY59180	59180	34.00

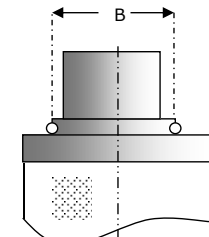
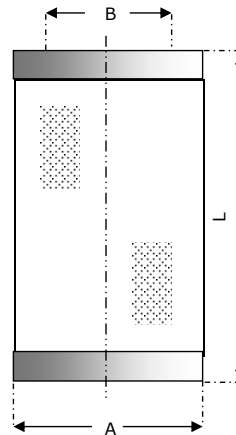

HY70539 & HY59180

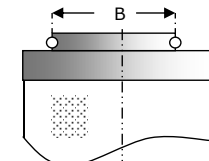

HY57029 & HY59177

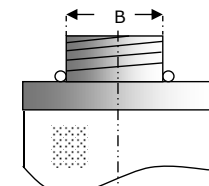

HY70166

Tiger P/No.	A (mm)	B (mm)	L (mm)
HY52022	70	40 (ID)	70
HY3415	70	40 (ID)	200
HY3407	70	40 (ID)	255
HY52471	70	40 (ID)	175
HY57029	70	40	84
HY59177	70	40	204
HY70166	21.5	1/8" BSP	31
HY70539	70	40	204
HY59180	70	40	255



Tiger Filtration Ltd

Unit 3, Rivergreen Industry Centre, Pallion, Sunderland, SR4 6AD, UK
 Tel: +44 (0) 191 565 5348 Fax: +44 (0) 191 564 0002 Email: sales@tigerfiltration.co.uk

Tiger Filtration Ltd

Ingersoll Rand

Alternative filter elements manufactured by **Tiger Filtration Ltd** to fit into **Ingersoll Rand** filter housings

Alternative Filter Elements



Grade AC			Activated Carbon		
Tiger P/No.	IR P/No.	List Price £	Tiger P/No.	IR P/No.	List Price £
IR5 (*)	5 (*)	39.00	IR5 AC	5 ACS	39.00
IR10 (*)	10 (*)	65.00	IR10 AC	10 ACS	65.00
IR18 (*)	18 (*)	76.00	IR18 AC	18 ACS	76.00
IR36 (*)	36 (*)	94.00	IR36 AC	36 ACS	94.00
IR48 (*)	48 (*)	123.00	IR48 AC	48 ACS	123.00
IR119 (*)	119 (*)	147.00	IR119 AC	119 ACS	147.00
IR198 (*)	198 (*)	212.00	IR198 AC	198 ACS	212.00
IR239 (*)	239 (*)	250.00	IR239 AC	239 ACS	250.00
IR372 (*)	372 (*)	339.00	IR372 AC	372 ACS	339.00

(*) = grade - Example: 5 AO order as IR5 M1
 M1 replaces AO & AR (1 Micron)
 MX replaces AA (0.01 Micron & 0.01mg/m³ oil removal)

Grade AC			Activated Carbon		
Tiger P/No.	IR P/No.	List Price £	Tiger P/No.	IR P/No.	List Price £
IR4 (*)	E4 (*)	39.00	IR4 ACC	E4 AC	33.00
IR8 (*)	E8 (*)	65.00	IR8 ACC	E8 AC	34.00
IR15 (*)	E15 (*)	76.00	IR15 ACC	E15 AC	49.00
IR24 (*)	E24 (*)	94.00	IR24 ACC	E24 AC	68.00
IR50 (*)	E50 (*)	123.00	IR39 ACC	E39 AC	119.00
IR125 (*)	E125 (*)	147.00	IR50 ACC	E50 AC	150.00
IR180 (*)	E180 (*)	212.00	IR125 AC	E125 AC	147.00
IR240 (*)	E240 (*)	250.00	IR180 AC	E180 AC	212.00
IR300 (*)	E300 (*)	339.00	IR240 AC	E240 AC	250.00
			IR300 AC	E300 AC	339.00

(*) = grade - Example: E4 AO order as IR4 M1
 M1 replaces AO & AR (1 Micron)
 MX replaces AA (0.01 Micron & 0.01mg/m³ oil removal)



Tiger Filtration Ltd

Unit 3, Rivergreen Industry Centre, Pallion, Sunderland, SR4 6AD, UK
 Tel: +44 (0) 191 565 5348 Fax: +44 (0) 191 564 0002 Email: sales@tigerfiltration.co.uk

Tiger Filtration Ltd

Kaeser

Alternative filter elements manufactured by **Tiger Filtration Ltd** to fit into **Kaeser** filter housings

Alternative Filter Elements



Tiger P/No.	Kaeser P/No.	List Price £
KS006 (*)	E - (*) - 6	46.00
KS010 (*)	E - (*) - 10	62.00
KS018 (*)	E - (*) - 18	81.00
KS028 (*)	E - (*) - 28	102.00
KS048 (*)	E - (*) - 48	127.00
KS071 (*)	E - (*) - 71	142.00
KS107 (*)	E - (*) - 107	178.00
KS138 (*)	E - (*) - 138	209.00
KS177 (*)	E - (*) - 177	238.00
KS185 (*)	E - (*) - 185	254.00
KS221 (*)	E - (*) - 221	246.00
KS283 (*)	E - (*) - 283	246.00

(*) = grade - Example: E-C-6 order as KS006 M1

M5 replaces B (5 Micron)

M1 replaces C (1 Micron)

MX replaces E (0.01 Micron & 0.01mg/m³ oil removal)

MXX replaces F (0.01 Micron & 0.001mg/m³ oil removal)

AC replaces G (Activated Carbon)

RM1 replaces D (1 micron)



Tiger Filtration Ltd

Unit 3, Rivergreen Industry Centre, Pallion, Sunderland, SR4 6AD, UK

Tel: +44 (0) 191 565 5348 Fax: +44 (0) 191 564 0002 Email: sales@tigerfiltration.co.uk

Tiger Filtration Ltd

Alternative Filter Elements

Leybold

Alternative air/oil separator elements manufactured by **Tiger Filtration Ltd** to fit into **Leybold** vacuum pumps



Tiger P/No.	Leybold P/No.	Pump Model	List Price £
LY023	712-32-023	SV16 - 25	59.00
LY763	710-64-763	SV40 - 200	70.00
LY773	710-64-773	SV280 - 1200	81.00
LY180	714-21-180	SV40B	44.00
LY300	714-17-300	SV65B - 100B	48.00
LY120	714-31-120	SV200B,300B,630B,750B	57.00
LY971	18971	D4A-B-AC,D8B,D2A-AC	45.00
LY973	18973	D40B-BCS, D65B-BCS	52.00
LY975	18975	D8A, D16A	45.00

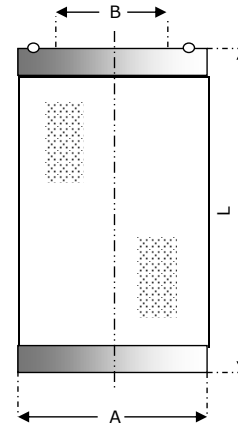

Tiger P/No.	A (mm)	B (mm)	L (mm)
LY023	55	24 (ID)	152
LY763	66	40 (ID)	228
LY773	66	40 (ID)	400
LY180	73	47.5 (ID)	188
LY300	73	47.5 (ID)	225
LY120	73	47.5 (ID)	401
LY971	54	25 (ID)	75
LY973	54	25 (ID)	175
LY975	54	25 (ID)	95



Tiger Filtration Ltd

Unit 3, Rivergreen Industry Centre, Pallion, Sunderland, SR4 6AD, UK

Tel: +44 (0) 191 565 5348 Fax: +44 (0) 191 564 0002 Email: sales@tigerfiltration.co.uk

Tiger Filtration Ltd

Mark

Alternative filter elements manufactured by **Tiger Filtration Ltd** to fit into **Mark** filter housings

Alternative Filter Elements



Tiger P/No.	Mark P/No.	List Price £
MK10 (*)	10 (*)	36.00
MK13 (*)	13 (*)	45.00
MK20 (*)	20 (*)	56.00
MK33 (*)	33 (*)	70.00
MK60 (*)	60 (*)	95.00
MK85 (*)	85 (*)	114.00
MK130 (*)	130 (*)	144.00
MK170 (*)	170 (*)	177.00
MK250 (*)	250 (*)	202.00
MK400 (*)	400 (*)	290.00

(*) = grade - Example: 10FPRE order as MK10 M1

M3 replaces FPRO (3 Micron)

M1 replaces FPPE (1 Micron)

M0 replaces FMO (0.1 Micron)

MX replaces FMM (0.01 Micron)

AC replaces FCA (Activated Carbon)



Tiger Filtration Ltd

Unit 3, Rivergreen Industry Centre, Pallion, Sunderland, SR4 6AD, UK

Tel: +44 (0) 191 565 5348 Fax: +44 (0) 191 564 0002 Email: sales@tigerfiltration.co.uk

Tiger Filtration Ltd

Mattei

Alternative filter elements manufactured by **Tiger Filtration Ltd** to fit into **Mattei** filter housings

Alternative Filter Elements



Tiger P/No.	Mattei P/No.	List Price £
MA005 (*)	04E 0030 (*)	26.00
MA010 (*)	04E 0060 (*)	30.00
MA018 (*)	04E 0108 (*)	39.00
MA030 (*)	04E 0180 (*)	42.00
MA034 (*)	04E 0204 (*)	45.00
MA050 (*)	04E 0300 (*)	54.00
MA072 (*)	04E 0432 (*)	60.00
MA095 (*)	04E 0570 (*)	79.00
MA125 (*)	04E 0750 (*)	103.00
MA165 (*)	04E 0990 (*)	126.00
MA190 (*)	04E 1140 (*)	135.00
MA220 (*)	04E 1320 (*)	176.00

(*) = grade - Example: 04E 0030 PF order as MA005 M1

M25 replaces D (25 Micron)

M5 replaces Q (5 Micron)

M1 replaces P (1 Micron)

MX replaces H (0.01 Micron & 0.01mg/m³ oil removal)

MXX replaces S (0.01 Micron & 0.001mg/m³ oil removal)

AC replaces C (Activated Carbon)



Tiger Filtration Ltd

Unit 3, Rivergreen Industry Centre, Pallion, Sunderland, SR4 6AD, UK

Tel: +44 (0) 191 565 5348 Fax: +44 (0) 191 564 0002 Email: sales@tigerfiltration.co.uk

Tiger Filtration Ltd

Mattei

Alternative air/oil separator elements manufactured by **Tiger Filtration Ltd** to fit into **Mattei** air compressors

Grade M1/RM1 1 Micron

Tiger P/No.	Mattei P/No.	List Price £
MA20113	CR2201130	38.00
MA30725	CR21F30725	34.00
MA30732	CR21A30732	32.00
MA30733	CR21H30733	42.00

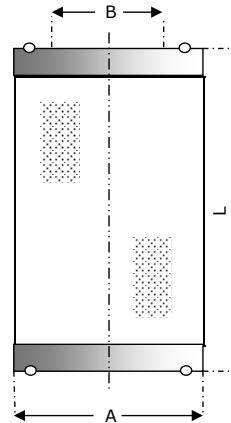

Tiger P/No.	A (mm)	B (mm)	L (mm)
MA20113	100	70 (ID)	252
MA30725	70	40 (ID)	200
MA30732	70	40 (ID)	255
MA30733	70	40 (ID)	400

Alternative Filter Elements



Tiger Filtration Ltd

Unit 3, Rivergreen Industry Centre, Pallion, Sunderland, SR4 6AD, UK
 Tel: +44 (0) 191 565 5348 Fax: +44 (0) 191 564 0002 Email: sales@tigerfiltration.co.uk

Tiger Filtration Ltd

MIKROPOR

Alternative filter elements manufactured by **Tiger Filtration Ltd** to fit into **MIKROPOR** filter housings

Alternative Filter Elements



Tiger P/No.	Mikropor P/No.	List Price £
MP24 (*)	M24 (*)	48.00
MP48 (*)	M48 (*)	48.00
MP25 (*)	M25 (*)	52.00
MP50 (*)	M50 (*)	52.00
MP100 (*)	M100 (*)	60.00
MP150 (*)	M150 (*)	70.00
MP200 (*)	M200 (*)	75.00
MP250 (*)	M250 (*)	79.00
MP300 (*)	M300 (*)	88.00
MP500 (*)	M500 (*)	98.00
MP600 (*)	M600 (*)	107.00
MP851 (*)	M851 (*)	193.00
MP1210 (*)	M1210 (*)	214.00
MP1510 (*)	M1510 (*)	247.00
MP1810 (*)	M1810 (*)	271.00
MP2210 (*)	M2210 (*)	294.00

(*) = grade - Example: M24 X order as MP24 M1
M5 replaces P (5 Micron)
M1 replaces X (1 Micron)
MX replaces Y (0.01 Micron & 0.01mg/m³ oil removal)
AC replaces A (Activated Carbon)



Tiger Filtration Ltd

Unit 3, Rivergreen Industry Centre, Pallion, Sunderland, SR4 6AD, UK
Tel: +44 (0) 191 565 5348 Fax: +44 (0) 191 564 0002 Email: sales@tigerfiltration.co.uk

Tiger Filtration Ltd

Alternative Filter Elements

M.T.A.

Alternative filter elements manufactured by **Tiger Filtration Ltd** to fit into **M.T.A.** filter housings



Tiger P/No.	MTA P/No.	List Price £
MT6050 (*)	6050 (*)	24.00
MT7050 (*)	7050 (*)	27.00
MT14050 (*)	14050 (*)	36.00
MT12075 (*)	12075 (*)	46.00
MT22075 (*)	22075 (*)	62.00
MT32075 (*)	32075 (*)	76.00
MT50075 (*)	50075 (*)	96.00
MT51090 (*)	51090 (*)	131.00
MT76090 (*)	76090 (*)	155.00
MT75140 (*)	75140 (*)	245.00

(*) = grade - Example: 6050M order as MT6050 M1
 M3 replaces P (3 Micron)
 M1 replaces M (1 Micron)
 MX replaces S (0.01 Micron & 0.01mg/m³ oil removal)
 AC replaces A (Activated Carbon)

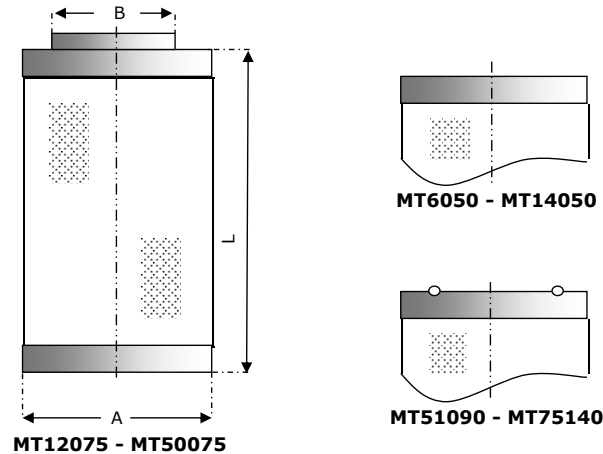

Tiger P/No.	A (mm)	B (mm)	L (mm)
MT6050	51	24 (ID)	61
MT7050	51	24 (ID)	72
MT14050	51	24 (ID)	140
MT12075	75	63	119
MT22075	75	63	219
MT32075	75	63	319
MT50075	75	63	500
MT51090	91	67 (ID)	509
MT76090	91	67 (ID)	766
MT75140	140	100 (ID)	751



Tiger Filtration Ltd

Unit 3, Rivergreen Industry Centre, Pallion, Sunderland, SR4 6AD, UK
 Tel: +44 (0) 191 565 5348 Fax: +44 (0) 191 564 0002 Email: sales@tigerfiltration.co.uk

Tiger Filtration Ltd

Omega

Alternative filter elements manufactured by **Tiger Filtration Ltd** to fit into **Omega** filter housings

Alternative Filter Elements



Tiger P/No.	Omega P/No.	List Price £
OM6050 (*)	06050 (*)	36.00
OM7050 (*)	07050 (*)	45.00
OM14050 (*)	14050 (*)	56.00
OM12075 (*)	12075 (*)	70.00
OM22075 (*)	22075 (*)	95.00
OM32075 (*)	32075 (*)	114.00
OM50075 (*)	50075 (*)	144.00
OM51090 (*)	51090 (*)	177.00
OM76090 (*)	76090 (*)	202.00
OM51140 (*)	51140 (*)	254.00
OM75140 (*)	75140 (*)	290.00

(*) = grade - Example: 06050 R order as OM6050 M1
M3 replaces P (3 Micron)
M1 replaces R (1 Micron)
M0 replaces M (0.1 Micron)
MX replaces S (0.01 Micron & 0.01mg/m³ oil removal)
AC replaces A (Activated Carbon)



Tiger Filtration Ltd

Unit 3, Rivergreen Industry Centre, Pallion, Sunderland, SR4 6AD, UK
Tel: +44 (0) 191 565 5348 Fax: +44 (0) 191 564 0002 Email: sales@tigerfiltration.co.uk

Tiger Filtration Ltd

OMI

Alternative filter elements manufactured by **Tiger Filtration Ltd** to fit into **OMI** filter housings

Alternative Filter Elements



Tiger P/No.	OMI P/No.	List Price £
OM005 (*)	04E 0030 (*)	26.00
OM010 (*)	04E 0060 (*)	30.00
OM018 (*)	04E 0108 (*)	39.00
OM030 (*)	04E 0180 (*)	42.00
OM034 (*)	04E 0204 (*)	45.00
OM050 (*)	04E 0300 (*)	54.00
OM072 (*)	04E 0432 (*)	60.00
OM095 (*)	04E 0570 (*)	79.00
OM125 (*)	04E 0750 (*)	103.00
OM165 (*)	04E 0990 (*)	126.00
OM190 (*)	04E 1140 (*)	135.00
OM220 (*)	04E 1320 (*)	176.00

(*) = grade - Example: 04E 0030 PF order as OM005 M1

M10 replaces DF (10 Micron)

M5 replaces QF (5 Micron)

M1 replaces PF (1 Micron)

MX replaces HF (0.01 Micron & 0.01mg/m³ oil removal)

AC replaces CF (Activated Carbon)



Tiger Filtration Ltd

Unit 3, Rivergreen Industry Centre, Pallion, Sunderland, SR4 6AD, UK

Tel: +44 (0) 191 565 5348 Fax: +44 (0) 191 564 0002 Email: sales@tigerfiltration.co.uk

Tiger Filtration Ltd

OMI-Previous

Alternative filter elements manufactured by **Tiger Filtration Ltd** to fit into **OMI** filter housings

Alternative Filter Elements



Grade M5 (QF) 5 Micron

Tiger P/No.	OMI P/No.	List Price £
OM005 M5	040 F050	26.00
OM010 M5	040 F051	30.00
OM018 M5	040 F052	39.00
OM034 M5	040 F053	45.00
OM050 M5	040 F054	54.00
OM095 M5	040 F055	79.00
OM125 M5	040 F056	103.00
OM125 M5	040 F057	103.00
OM165 M5	040 F058	126.00
OM220 M5	040 F059	176.00

Grade M1 (PF) 1 Micron

Tiger P/No.	OMI P/No.	List Price £
OM005 M1	041 F150	26.00
OM010 M1	041 F151	30.00
OM018 M1	041 F152	39.00
OM034 M1	041 F153	45.00
OM050 M1	041 F154	54.00
OM095 M1	041 F155	79.00
OM125 M1	041 F156	103.00
OM125 M1	041 F157	103.00
OM165 M1	041 F158	126.00
OM220 M1	041 F159	176.00

Grade M0 (HF) 0.1 Micron

Tiger P/No.	OMI P/No.	List Price £
OM005 M0	042 F250	26.00
OM010 M0	042 F251	30.00
OM018 M0	042 F252	39.00
OM034 M0	042 F253	45.00
OM050 M0	042 F254	54.00
OM095 M0	042 F255	79.00
OM125 M0	042 F256	103.00
OM125 M0	042 F257	103.00
OM165 M0	042 F258	126.00
OM220 M0	042 F259	176.00

Grade AC (CF) Activated Carbon

Tiger P/No.	OMI P/No.	List Price £
OM005 AC	043 F350	26.00
OM010 AC	043 F351	30.00
OM018 AC	043 F352	39.00
OM034 AC	043 F353	45.00
OM050 AC	043 F354	54.00
OM095 AC	043 F355	79.00
OM125 AC	043 F356	103.00
OM125 AC	043 F357	103.00
OM165 AC	043 F358	126.00
OM220 AC	043 F359	176.00



Tiger Filtration Ltd

Unit 3, Rivergreen Industry Centre, Pallion, Sunderland, SR4 6AD, UK

Tel: +44 (0) 191 565 5348 Fax: +44 (0) 191 564 0002 Email: sales@tigerfiltration.co.uk

Tiger Filtration Ltd

Pall/PPC

Alternative filter elements manufactured by **Tiger Filtration Ltd** to fit into **Pall/PPC** filter housings

Alternative Filter Elements



Tiger P/No.	Pall P/No.	List Price £
P3A13 M3	PPFK3A13 AF	POA
P3A13 MX	PPFK3A13 SU	POA
P3A13 HT	PPFK3A13 HT	POA
P3A13 AC	PPFK3A13 A	POA

Tiger P/No.	Pall P/No.	List Price £
P2A10 M3	PPFK2A10 AF	POA
P2A10 MX	PPFK2A10 SU	POA
P2A10 HT	PPFK2A10 HT	POA
P2A10 AC	PPFK2A10 A	POA



Tiger Filtration Ltd

Unit 3, Rivergreen Industry Centre, Pallion, Sunderland, SR4 6AD, UK

Tel: +44 (0) 191 565 5348 Fax: +44 (0) 191 564 0002 Email: sales@tigerfiltration.co.uk

Tiger Filtration Ltd

Pneumatech

Alternative filter elements manufactured by **Tiger Filtration Ltd** to fit into **Pneumatech** filter housings

Alternative Filter Elements



Grade M3 3 Micron

Tiger P/No.	Pn-tech P/No.	List Price £
PT01 M3	1624-5000-01	36.00
PT06 M3	1624-5000-06	45.00
PT11 M3	1624-5000-11	56.00
PT16 M3	1624-5000-16	70.00
PT21 M3	1624-5000-21	95.00
PT26 M3	1624-5000-26	114.00
PT31 M3	1624-5000-31	144.00
PT36 M3	1624-5000-36	177.00
PT41 M3	1624-5000-41	202.00
PT46 M3	1624-5000-46	254.00
PT51 M3	1624-5000-51	290.00

Grade M1 1 Micron

Tiger P/No.	Pn-tech P/No.	List Price £
PT05 M1	1624-5000-05	36.00
PT10 M1	1624-5000-10	45.00
PT15 M1	1624-5000-15	56.00
PT20 M1	1624-5000-20	70.00
PT25 M1	1624-5000-25	95.00
PT30 M1	1624-5000-30	114.00
PT35 M1	1624-5000-35	144.00
PT40 M1	1624-5000-40	177.00
PT45 M1	1624-5000-45	202.00
PT50 M1	1624-5000-50	254.00
PT55 M1	1624-5000-55	290.00

Grade M0 0.1 Micron

Tiger P/No.	Pn-tech P/No.	List Price £
PT04 M0	1624-5000-04	36.00
PT09 M0	1624-5000-09	45.00
PT14 M0	1624-5000-14	56.00
PT19 M0	1624-5000-19	70.00
PT24 M0	1624-5000-24	95.00
PT29 M0	1624-5000-29	114.00
PT34 M0	1624-5000-34	144.00
PT39 M0	1624-5000-39	177.00
PT44 M0	1624-5000-44	202.00
PT49 M0	1624-5000-49	254.00
PT54 M0	1624-5000-54	290.00

Grade MX 0.01 Micron

Tiger P/No.	Pn-tech P/No.	List Price £
PT02 MX	1624-5000-02	36.00
PT07 MX	1624-5000-07	45.00
PT12 MX	1624-5000-12	56.00
PT17 MX	1624-5000-17	70.00
PT22 MX	1624-5000-22	95.00
PT27 MX	1624-5000-27	114.00
PT32 MX	1624-5000-32	144.00
PT37 MX	1624-5000-37	177.00
PT42 MX	1624-5000-42	202.00
PT47 MX	1624-5000-47	254.00
PT52 MX	1624-5000-52	290.00

Grade AC Activated Carbon

Tiger P/No.	Pn-tech P/No.	List Price £
PT03 AC	1624-5000-03	36.00
PT08 AC	1624-5000-08	45.00
PT13 AC	1624-5000-13	56.00
PT18 AC	1624-5000-18	70.00
PT23 AC	1624-5000-23	95.00
PT28 AC	1624-5000-28	114.00
PT33 AC	1624-5000-33	144.00
PT38 AC	1624-5000-38	177.00
PT43 AC	1624-5000-43	202.00
PT48 AC	1624-5000-48	254.00
PT53 AC	1624-5000-53	290.00



Tiger Filtration Ltd

Unit 3, Rivergreen Industry Centre, Pallion, Sunderland, SR4 6AD, UK

Tel: +44 (0) 191 565 5348 Fax: +44 (0) 191 564 0002 Email: sales@tigerfiltration.co.uk

Tiger Filtration Ltd

Puska

Alternative filter elements manufactured by **Tiger Filtration Ltd** to fit into **Puska** filter housings

Alternative Filter Elements



Tiger P/No.	Puska P/No.	List Price £
PK10 (*)	(*) 10	36.00
PK13 (*)	(*) 13	45.00
PK20 (*)	(*) 20	56.00
PK33 (*)	(*) 33	70.00
PK60 (*)	(*) 60	95.00
PK85 (*)	(*) 85	114.00
PK130 (*)	(*) 130	144.00
PK170 (*)	(*) 170	177.00
PK250 (*)	(*) 250	202.00

(*) = grade - Example: PMO10 order as PK10 M1
M3 replaces PRO (3 Micron)
M1 replaces PMO (1 Micron)
MX replaces PMM (0.01 Micron)
AC replaces PCA (Activated Carbon)



Tiger Filtration Ltd

Unit 3, Rivergreen Industry Centre, Pallion, Sunderland, SR4 6AD, UK
Tel: +44 (0) 191 565 5348 Fax: +44 (0) 191 564 0002 Email: sales@tigerfiltration.co.uk

Tiger Filtration Ltd

PVR

Alternative air/oil separator elements manufactured by **Tiger Filtration Ltd** to fit into **PVR** vacuum pumps

Alternative Filter Elements



Tiger P/No.	PVR P/No.	Pump Model	List Price £
PV2556	002556	EV45/65	34.00
PV3957	003957	EV105	55.00
PV4391	004391	EV160	41.00
PV3604	003604	EV205/300	48.00
PV5099	005099	EV650	65.00

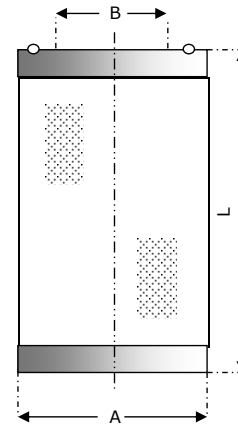

Tiger P/No.	A (mm)	B (mm)	L (mm)
PV2556	74	35	252
PV3957	100	60	260
PV4391	74	35	300
PV3604	80	45	362
PV5099	80	45	528



Tiger Filtration Ltd

Unit 3, Rivergreen Industry Centre, Pallion, Sunderland, SR4 6AD, UK
 Tel: +44 (0) 191 565 5348 Fax: +44 (0) 191 564 0002 Email: sales@tigerfiltration.co.uk

Tiger Filtration Ltd

Rietschle

Alternative filter elements manufactured by **Tiger Filtration Ltd** to fit into **Rietschle** vacuum pumps

Alternative Filter Elements



Tiger P/No.	Rietschle P/No.	Previous Model	List Price £
RT399	731-399	730-946	39.00
RT311	731-311	731-023	41.00
RT400	731-400	730-936	39.00
RT401	731-401	730-937	50.00

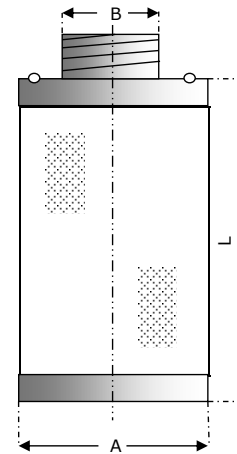

Tiger P/No.	A (mm)	B (mm)	L (mm)
RT399	56	M24	78
RT311	56	M24	123
RT400	72	M33	83
RT401	80	M45	127



Tiger Filtration Ltd

Unit 3, Rivergreen Industry Centre, Pallion, Sunderland, SR4 6AD, UK

Tel: +44 (0) 191 565 5348 Fax: +44 (0) 191 564 0002 Email: sales@tigerfiltration.co.uk

Tiger Filtration Ltd

Sotras

Alternative filter elements manufactured by **Tiger Filtration Ltd** to fit into **Sotras** filter housings

Alternative Filter Elements



Grade M3(Pre-Filter) 3 Micron

Tiger P/No.	Sotras P/No.	List Price £
ST9017 M3	SM 9017	24.00
ST9021 M3	SM 9021	27.00
ST9025 M3	SM 9025	36.00
ST9029 M3	SM 9029	46.00
ST9033 M3	SM 9033	62.00
ST9037 M3	SM 9037	76.00
ST9041 M3	SM 9041	96.00
ST9045 M3	SM 9045	131.00
ST9049 M3	SM 9049	155.00
ST9053 M3	SM 9053	245.00

Grade M0(Fine Filter) 0.1 Micron

Tiger P/No.	Sotras P/No.	List Price £
ST9018 M0	SM 9018	24.00
ST9022 M0	SM 9022	27.00
ST9026 M0	SM 9026	36.00
ST9030 M0	SM 9030	46.00
ST9034 M0	SM 9034	62.00
ST9038 M0	SM 9038	76.00
ST9042 M0	SM 9042	96.00
ST9046 M0	SM 9046	131.00
ST9050 M0	SM 9050	155.00
ST9054 M0	SM 9054	245.00

Grade MX (Micro Filter) 0.01 Micron

Tiger P/No.	Sotras P/No.	List Price £
ST9019 MX	SM 9019	24.00
ST9023 MX	SM 9023	27.00
ST9027 MX	SM 9027	36.00
ST9031 MX	SM 9031	46.00
ST9035 MX	SM 9035	62.00
ST9039 MX	SM 9039	76.00
ST9043 MX	SM 9043	96.00
ST9047 MX	SM 9047	131.00
ST9051 MX	SM 9051	155.00
ST9055 MX	SM 9055	245.00

Grade AC (Activated Carbon) Activated Carbon

Tiger P/No.	Sotras P/No.	List Price £
ST9020 AC	SM 9020	24.00
ST9024 AC	SM 9024	27.00
ST9028 AC	SM 9028	36.00
ST9032 AC	SM 9032	46.00
ST9036 AC	SM 9036	62.00
ST9040 AC	SM 9040	76.00
ST9044 AC	SM 9044	96.00
ST9048 AC	SM 9048	131.00
ST9052 AC	SM 9052	155.00
ST9056 AC	SM 9056	245.00



Tiger Filtration Ltd

Unit 3, Rivergreen Industry Centre, Pallion, Sunderland, SR4 6AD, UK
 Tel: +44 (0) 191 565 5348 Fax: +44 (0) 191 564 0002 Email: sales@tigerfiltration.co.uk

Tiger Filtration Ltd

Sullair

Alternative filter elements manufactured by **Tiger Filtration Ltd** to fit into **Sullair** filter housings

Alternative Filter Elements



Grade M1 1 Micron

Tiger P/No.	Sullair P/No.	List Price £
SU423 M1	250024-423	39.00
SU424 M1	250024-424	65.00
SU425 M1	250024-425	76.00
SU426 M1	250024-426	94.00
SU427 M1	250024-427	123.00
SU428 M1	250024-428	147.00
SU429 M1	250024-429	212.00
SU644 M1	250024-644	250.00
SU430 M1	250024-430	339.00

Grade MX 0.01 Micron

Tiger P/No.	Sullair P/No.	List Price £
SU431 MX	250024-431	39.00
SU432 MX	250024-432	65.00
SU433 MX	250024-433	76.00
SU434 MX	250024-434	94.00
SU435 MX	250024-435	123.00
SU436 MX	250024-436	147.00
SU437 MX	250024-437	212.00
SU655 MX	250024-655	250.00
SU438 MX	250024-438	339.00

Grade AC Activated Carbon

Tiger P/No.	Sullair P/No.	List Price £
SU443 AC	250024-443	39.00
SU444 AC	250024-444	65.00
SU445 AC	250024-445	76.00
SU446 AC	250024-446	94.00
SU447 AC	250024-447	123.00
SU439 AC	250024-439	147.00
SU440 AC	250024-440	212.00
SU646 AC	250024-646	250.00
SU441 AC	250024-441	339.00



Tiger Filtration Ltd

Unit 3, Rivergreen Industry Centre, Pallion, Sunderland, SR4 6AD, UK

Tel: +44 (0) 191 565 5348 Fax: +44 (0) 191 564 0002 Email: sales@tigerfiltration.co.uk

Tiger Filtration Ltd

Alternative Filter Elements

Tepro

Alternative air/oil separator elements manufactured by **Tiger Filtration Ltd** to fit into **Tepro** vacuum pumps



Tiger P/No.	Tepro P/No.	Pump Model	List Price £
TP713	FPS70x130	AT21/21A	24.00
TP716	FPS70x160	AT21B/40B	27.00
TP725	FPS70x250	AT63B/100B	36.00

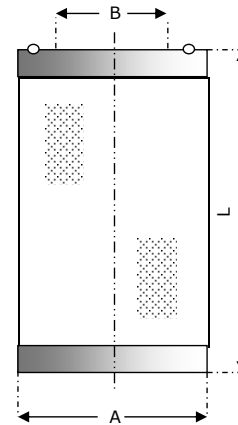

Tiger P/No.	A (mm)	B (mm)	L (mm)
TP713	70	29 (ID)	130
TP716	70	29 (ID)	160
TP725	70	29 (ID)	250



Tiger Filtration Ltd

Unit 3, Rivergreen Industry Centre, Pallion, Sunderland, SR4 6AD, UK

Tel: +44 (0) 191 565 5348 Fax: +44 (0) 191 564 0002 Email: sales@tigerfiltration.co.uk

Tiger Filtration Ltd

Ultrafilter (90 Series)

Alternative filter elements manufactured by **Tiger Filtration Ltd** to fit into **Ultrafilter (90 Series)** filter housings

Standard Elements

Tiger P/no.	UF P/No.	List Price £
UF0205 (*)	(*) 02/05	45.00
UF0210 (*)	(*) 02/10	46.00
UF0305 (*)	(*) 03/05	50.00
UF0310 (*)	(*) 03/10	57.00
UF0410 (*)	(*) 04/10	63.00
UF0420 (*)	(*) 04/20	74.00
UF0520 (*)	(*) 05/20	83.00
UF0525 (*)	(*) 05/25	95.00
UF0725 (*)	(*) 07/25	110.00
UF0730 (*)	(*) 07/30	131.00
UF1030 (*)	(*) 10/30	163.00
UF1530 (*)	(*) 15/30	181.00
UF2030 (*)	(*) 20/30	212.00
UF3030 (*)	(*) 30/30	288.00
UF3050 (*)	(*) 30/50	425.00

(*) = grade - Example: FF02/05 order as UF0205 M1
 M25 replaces V-PE (25 Micron)
 M1 replaces FF (1 Micron)
 M0 replaces MF (0.1 Micron & oil removal)
 MX replaces SMF (0.01 Micron & 0.01mg/m³ oil removal)
 AC replaces AK (Activated Carbon)

Alternative Filter Elements



HT/CR or HT/NX Range

Tiger P/no.	UF P/No.	List Price £
UFHT0205 (*)	(*) 02/05	POA
UFHT0305 (*)	(*) 03/05	POA
UFHT0310 (*)	(*) 03/10	POA
UFHT0410 (*)	(*) 04/10	POA
UFHT0420 (*)	(*) 04/20	POA
UFHT0520 (*)	(*) 05/20	POA
UFHT0525 (*)	(*) 05/25	POA
UFHT0725 (*)	(*) 07/25	POA
UFHT0730 (*)	(*) 07/30	POA
UFHT1030 (*)	(*) 10/30	POA
UFHT1530 (*)	(*) 15/30	POA
UFHT2030 (*)	(*) 20/30	POA
UFHT3030 (*)	(*) 30/30	POA
UFHT3050 (*)	(*) 30/50	POA

(*) = grade - Example: FF02/05 order as UFHT0205 M1
 M1 replaces FF (1 Micron)
 M0 replaces MF (0.1 Micron & oil removal)
 MX replaces SMF (0.01 Micron & 0.01mg/m³ oil removal)



Tiger Filtration Ltd

Unit 3, Rivergreen Industry Centre, Pallion, Sunderland, SR4 6AD, UK
 Tel: +44 (0) 191 565 5348 Fax: +44 (0) 191 564 0002 Email: sales@tigerfiltration.co.uk

Tiger Filtration Ltd

Ultrafilter (80 Series)

Alternative filter elements manufactured by **Tiger Filtration Ltd** to fit into **Ultrafilter (80 Series)** filter housings

Standard Elements

Tiger P/No.	UF P/No.	List Price £
UF425 (*)	(*) 4/2.5	94.00
UF525 (*)	(*) 5/2.5	95.00
UF53 (*)	(*) 5/3	127.00
UF103 (*)	(*) 10/3	161.00
UF153 (*)	(*) 15/3	181.00
UF203 (*)	(*) 20/3	209.00
UF303 (*)	(*) 30/3	261.00
UF305 (*)	(*) 30/5	404.00

(*) = grade - Example: FF4/2.5 order as UF425 M1
 M25 replaces V (25 Micron)
 M1 replaces FF (1 Micron)
 M0 replaces MF (0.1 Micron & oil removal)
 MX replaces SMF (0.01 Micron & 0.01mg/m³ oil removal)
 AC replaces AK (Activated Carbon)

HT/CR or HT/NX Range

Tiger P/No.	UF P/No.	List Price £
UFHT 103 (*)	(*) 10/3	POA
UFHT 153 (*)	(*) 15/3	POA
UFHT 203 (*)	(*) 20/3	POA
UFHT 303 (*)	(*) 30/3	POA
UFHT 305 (*)	(*) 30/5	POA

(*) = grade - Example: FF103 order as UFHT103 M1
 M1 replaces FF (1 Micron)
 M0 replaces MF (0.1 Micron & oil removal)
 MX replaces SMF (0.01 Micron & 0.01mg/m³ oil removal)

Alternative Filter Elements



Tiger Filtration Ltd

Unit 3, Rivergreen Industry Centre, Pallion, Sunderland, SR4 6AD, UK
 Tel: +44 (0) 191 565 5348 Fax: +44 (0) 191 564 0002 Email: sales@tigerfiltration.co.uk

Tiger Filtration Ltd

Van Air Systems

Alternative filter elements manufactured by **Tiger Filtration Ltd** to fit into **Van Air Systems** filter housings

A Range

Tiger P/No.	Van Air P/No.	List Price £
VA200-15 (*)	E200-15 (*)	38.00
VA200-25 (*)	E200-25 (*)	54.00
VA200-55 (*)	E200-55 (*)	64.00
VA200-85 (*)	E200-85 (*)	93.00
VA200-100 (*)	E200-100 (*)	110.00
VA200-150 (*)	E200-150 (*)	126.00
VA200-265 (*)	E200-265 (*)	140.00
VA200-350 (*)	E200-350 (*)	169.00
VA200-400 (*)	E200-400 (*)	169.00
VA200-500 (*)	E200-500 (*)	209.00
VA200-600 (*)	E200-600 (*)	248.00
VA200-800 (*)	E200-800 (*)	327.00
VA200-1000 (*)	E200-1000 (*)	386.00

(*) = grade - Example: E200-15 B order as VA200-15 M1
 M25 replaces AA (25 Micron)
 M5 replaces A (5 Micron)
 M1 replaces B (1 Micron)
 MX replaces C (0.01 micron)
 AC replaces D (Activated Carbon)

Alternative Filter Elements



Previous

Tiger P/No.	Van Air P/No.	List Price £
VA100-15 (*)	E100-15 (*)	52.00
VA100-30 (*)	E100-30 (*)	64.00
VA100-50 (*)	E100-50 (*)	71.00
VA100-75 (*)	E100-75 (*)	93.00
VA100-100 (*)	E100-100 (*)	109.00
VA100-150 (*)	E100-150 (*)	126.00
VA100-225 (*)	E100-225 (*)	140.00
VA100-350 (*)	E100-350 (*)	169.00
VA100-500 (*)	E100-500 (*)	206.00
VA100-750 (*)	E100-750 (*)	328.00
VA100-1000 (*)	E100-1000 (*)	386.00
VA101/102-500 (*)	E101/102-500 (*)	202.00
VA101/102-625 (*)	E101/102-625 (*)	218.00

(*) = grade - Example: E100-15 B order as VA100-15 M1
 M25 replaces AA (25 Micron)
 M5 replaces A (5 Micron)
 M1 replaces B (1 Micron)
 MX replaces C (0.01 micron)
 AC replaces D (Activated Carbon)



Tiger Filtration Ltd

Unit 3, Rivergreen Industry Centre, Pallion, Sunderland, SR4 6AD, UK
 Tel: +44 (0) 191 565 5348 Fax: +44 (0) 191 564 0002 Email: sales@tigerfiltration.co.uk

Tiger Filtration Ltd

Walker

Alternative filter elements manufactured by **Tiger Filtration Ltd** to fit into **Walker** filter housings

Tiger P/No.	Walker P/No.	List Price £
WF361 (*)	E361 (*)	38.00
WF381 ACC	E381 AC	29.00
WF371 (*)	E371 (*)	54.00
WF511 (*)	E511 (*)	64.00
WF711 (*)	E711 (*)	93.00
WF811 (*)	E811 (*)	110.00
WF731 (*)	E731 (*)	126.00
WF821 (*)	E821 (*)	140.00
WF831 (*)	E831 (*)	169.00
WF851 (*)	E851 (*)	209.00
WF1251 (*)	E1251 (*)	248.00
WF1261 (*)	E1261 (*)	327.00
WF1281 (*)	E1281 (*)	386.00
WF139 (*)	E139 (*)	432.00
WF88 (*)	E88 (*)	233.00

(*) = grade - Example: E361 X1 order as WF361 M1
M25 replaces X25 (25 Micron)
M5 replaces X5 (5 Micron)
M1 replaces X1 (1 Micron)
MX replaces XA (0.01 micron)
AC replaces AC (Activated Carbon)

Medical Vacuum Elements

Tiger P/No.	Walker P/No.	List Price £
WF511 MV	E511 MV	64.00
WF521 MV	E521 MV	83.00
WF811 MV	E811 MV	110.00
WF821 MV	E821 MV	140.00
WF831 MV	E831 MV	169.00
WF851 MV	E851 MV	209.00
WF1261 MV	E1261 MV	327.00
WF1281 MV	E1281 MV	386.00
WF139 MV	E139 MV	562.00
WF88 MV	E88 MV	255.00



Tiger Filtration Ltd

Unit 3, Rivergreen Industry Centre, Pallion, Sunderland, SR4 6AD, UK
Tel: +44 (0) 191 565 5348 Fax: +44 (0) 191 564 0002 Email: sales@tigerfiltration.co.uk

Alternative Filter Elements



High Pressure Elements - 50 Barg

Tiger P/No.	Walker P/No.	List Price £
WF50 (*)	E50 (*)	52.00
WF51 (*)	E51 (*)	64.00
WF52 (*)	E52 (*)	71.00
WF715 (*)	E715 (*)	93.00
WF730 (*)	E730 (*)	126.00
WF830 (*)	E830 (*)	140.00
WF86 (*)	E86 (*)	202.00

High Pressure Elements - 100 Barg

Tiger P/No.	Walker P/No.	List Price £
WFHP371 (*)	HP371 (*)	88.00
WFHP381 (*)	HP381 (*)	107.00
WFHP420 (*)	HP420 (*)	129.00
WFHP710 (*)	HP710 (*)	157.00
WFHP730 (*)	HP730 (*)	183.00
WFHP830 (*)	HP830 (*)	201.00
WFHP860 (*)	HP860 (*)	277.00

High Pressure Elements - 350 Barg

Tiger P/No.	Walker P/No.	List Price £
WFHP261 (*)	HP261 (*)	65.00
WFHP371 (*)	HP371 (*)	88.00
WFHP410 (*)	HP410 (*)	108.00
WFHP420 (*)	HP420 (*)	129.00
WFHP710 (*)	HP710 (*)	157.00
WFHP730 (*)	HP730 (*)	183.00

(*) = grade - Example: E50 X1 order as WF50 M1
M25 replaces X25 (25 Micron)
M5 replaces X5 (5 Micron)
M1 replaces X1 (1 Micron)
MX replaces XA (0.01 micron)
AC replaces AC (Activated Carbon)

Tiger Filtration Ltd

Walker - Alloy High Pressure Elements

Alternative filter elements manufactured by **Tiger Filtration Ltd** to fit into **Walker** filter housings

20 Bar Alloy High Pressure

Tiger P/No.	Walker P/No.	List Price £
WF1003 (*)	E1003 (*)	54.00
WF1503 (*)	E1503 (*)	54.00
WF2005 (*)	E2005 (*)	80.00
WF2505 (*)	E2505 (*)	115.00
WF2008 (*)	E2008 (*)	115.00
WF2508 (*)	E2508 (*)	141.00
WF2512 (*)	E2512 (*)	166.00
WF2712 (*)	E2712 (*)	187.00
WF3012 (*)	E3012 (*)	206.00
WF3020 (*)	E3020 (*)	243.00
WF5020 (*)	E5020 (*)	299.00
WF5024 (*)	E5024 (*)	394.00
WF5030 (*)	E5030 (*)	445.00

(*) = grade - Example: E1003 X1 order as WF1003 M1
 M25 replaces X25 (25 Micron)
 M5 replaces X5 (5 Micron)
 M1 replaces X1 (1 Micron)
 MX replaces XA (0.01 micron)
 AC replaces AC (Activated Carbon)

Alternative Filter Elements



50 Bar Alloy High Pressure

Tiger P/No.	Walker P/No.	List Price £
WFHP1535 (*)	HP1535 (*)	64.00
WFHP1550 (*)	HP1550 (*)	69.00
WFHP2040 (*)	HP2040 (*)	81.00
WFHP2540 (*)	HP2540 (*)	106.00
WFHP2080 (*)	HP2080 (*)	145.00
WFHP2580 (*)	HP2580 (*)	171.00
WFHP2512 (*)	HP2512 (*)	235.00
WFHP2520 (*)	HP2520 (*)	302.00

(*) = grade - Example: HP1535 X1 order as WFHP1535 M1
 M25 replaces X25 (25 Micron)
 M5 replaces X5 (5 Micron)
 M1 replaces X1 (1 Micron)
 MX replaces XA (0.01 micron)
 AC replaces AC (Activated Carbon)



Tiger Filtration Ltd

Unit 3, Rivergreen Industry Centre, Pallion, Sunderland, SR4 6AD, UK
 Tel: +44 (0) 191 565 5348 Fax: +44 (0) 191 564 0002 Email: sales@tigerfiltration.co.uk

Tiger Filtration Ltd

Walker - Medical Sterile Elements - A Range and Previous

Alternative filter elements manufactured by **Tiger Filtration Ltd** to fit into **Walker** filter housings

Medical Sterile A Range

Tiger P/No.	Walker P/No.	List Price £
WF361 SR	E361 SR	77.00
WF371 SR	E371 SR	94.00
WF511 SR	E511 SR	103.00
WF711 SR	E711 SR	137.00
WF811 SR	E811 SR	153.00
WF731 SR	E731 SR	169.00
WF821 SR	E821 SR	211.00
WF831 SR	E831 SR	244.00
WF851 SR	E851 SR	355.00
WF1251 SR	E1251 SR	468.00
WF1261 SR	E1261 SR	545.00
WF1281 SR	E1281 SR	682.00

Alternative Filter Elements



Medical Sterile - Previous

Tiger P/No.	Walker P/No.	List Price £
WF50 SR	E50 SR	81.00
WF51 SR	E51 SR	97.00
WF52 SR	E52 SR	107.00
WF71 SR	E71 SR	141.00
WF81 SR	E81 SR	160.00
WF73 SR	E73 SR	176.00
WF83 SR	E83 SR	190.00
WF831 SR	E831 SR	244.00
WF123 SR	E123 SR	364.00
WF125 SR	E125 SR	482.00
WF134 SR	E134 SR	364.00
WF135 SR	E135 SR	487.00
WF127 SR	E127 SR	562.00
WF128 SR	E128 SR	698.00



Tiger Filtration Ltd

Unit 3, Rivergreen Industry Centre, Pallion, Sunderland, SR4 6AD, UK

Tel: +44 (0) 191 565 5348 Fax: +44 (0) 191 564 0002 Email: sales@tigerfiltration.co.uk

Tiger Filtration Ltd

Walker - Previous

Alternative filter elements manufactured by **Tiger Filtration Ltd** to fit into **Walker** filter housings

Tiger P/No.	Walker P/No.	List Price £
WF50 (*)	E50 (*)	52.00
WF51 (*)	E51 (*)	64.00
WF52 (*)	E52 (*)	71.00
WF71 (*)	E71 (*)	93.00
WF81 (*)	E81 (*)	109.00
WF73 (*)	E73 (*)	126.00
WF83 (*)	E83 (*)	140.00
WF103 (*)	E103 (*)	169.00
WF123 (*)	E123 (*)	206.00
WF125 (*)	E125 (*)	248.00
WF134 (*)	E134 (*)	209.00
WF135 (*)	E135 (*)	248.00
WF127 (*)	E127 (*)	328.00
WF128 (*)	E128 (*)	376.00
WF830 (*)	E830 (*)	140.00
WF86 (*)	E86 (*)	202.00
WF87 (*)	E87 (*)	218.00
WF137 (*)	E137 (*)	312.00
WF138 (*)	E138 (*)	394.00

(*) = grade - Example: E50 X1 order as WF50 M1
M25 replaces X25 (25 Micron)
M5 replaces X5 (5 Micron)
M1 replaces X1 (1 Micron)
MX replaces XA (0.01 micron)
AC replaces AC (Activated Carbon)

Alternative Filter Elements



Medical Vacuum Elements

Tiger P/No.	Walker P/No.	List Price £
WF27 MV	E27 MV	49.00
WF37 MV	E37 MV	60.00
WF57 MV	E57 MV	75.00
WF81 MV	E81 MV	106.00
WF83 MV	E83 MV	160.00
WF103 MV	E103 MV	191.00
WF133 MV	E133 MV	233.00
WF137 MV	E137 MV	298.00
WF138 MV	E138 MV	333.00

High Pressure Elements

Tiger P/No.	Walker P/No.	List Price £
WFHP260 (*)	HP260 (*)	65.00
WFHP310 (*)	HP310 (*)	88.00

(*) = grade - Example: HP260 X1 order as WFHP260 M1
M25 replaces X25 (25 Micron)
M5 replaces X5 (5 Micron)
M1 replaces X1 (1 Micron)
MX replaces XA (0.01 micron)
AC replaces AC (Activated Carbon)



Tiger Filtration Ltd

Unit 3, Rivergreen Industry Centre, Pallion, Sunderland, SR4 6AD, UK
Tel: +44 (0) 191 565 5348 Fax: +44 (0) 191 564 0002 Email: sales@tigerfiltration.co.uk

Tiger Filtration Ltd

Alternative Filter Elements

Worthington Creyssensac

Alternative filter elements manufactured by **Tiger Filtration Ltd** to fit into **Worthington Creyssensac** filter housings



Tiger P/No.	Worthington P/No.	List Price £
WC60 (*)	D60 (*)	36.00
WC80 (*)	D80 (*)	45.00
WC120 (*)	D120 (*)	56.00
WC200 (*)	D200 (*)	70.00
WC340 (*)	D340 (*)	95.00
WC510 (*)	D510 (*)	114.00
WC800 (*)	D800 (*)	144.00
WC1000 (*)	D1000 (*)	177.00
WC1500 (*)	D1500 (*)	202.00
WC2400 (*)	D2400 (*)	290.00

(*) = grade - Example: D60 D order as WC60 M1

M3 replaces P (3 Micron)

M1 replaces D (1 Micron)

M0 replaces M (0.1 Micron)

MX replaces S (0.01 Micron)

AC replaces A (Activated Carbon)



Tiger Filtration Ltd

Unit 3, Rivergreen Industry Centre, Pallion, Sunderland, SR4 6AD, UK

Tel: +44 (0) 191 565 5348 Fax: +44 (0) 191 564 0002 Email: sales@tigerfiltration.co.uk

Tiger Filtration Ltd

Zander (Parker)

Alternative filter elements manufactured by **Tiger Filtration Ltd** to fit into **Zander (Parker)** filter housings

Alternative Filter Elements



Tiger P/No.	Zander P/No.	List Price £
ZA103 (*)	1030 (*)	58.00
ZA105 (*)	1050 (*)	68.00
ZA107 (*)	1070 (*)	80.00
ZA114 (*)	1140 (*)	99.00
ZA201 (*)	2010 (*)	131.00
ZA202 (*)	2020 (*)	168.00
ZA203 (*)	2030 (*)	209.00
ZA205 (*)	2050 (*)	269.00
ZA305 (*)	3050 (*)	316.00
ZA307 (*)	3075 (*)	369.00
ZA506 (*)	5060 (*)	508.00
ZA507 (*)	5075 (*)	613.00

(*) = grade - Example: 1050 Z order as ZA105 M1

M5 replaces V (5 Micron)

M1 replaces Z (1 Micron)

M0 replaces Y (0.1 Micron)

MX replaces X (0.01 Micron & 0.01mg/m³ oil removal)

AC replaces A (Activated Carbon)



Tiger Filtration Ltd

Unit 3, Rivergreen Industry Centre, Pallion, Sunderland, SR4 6AD, UK

Tel: +44 (0) 191 565 5348 Fax: +44 (0) 191 564 0002 Email: sales@tigerfiltration.co.uk

Tiger Filtration Ltd

Zeks

Alternative filter elements manufactured by **Tiger Filtration Ltd** to fit into **Zeks** filter housings

Alternative Filter Elements



Tiger P/No.	Zeks P/No.	List Price £
ZK15 (*)	E15 (*)	30.00
ZK30 (*)	E30 (*)	31.00
ZK32 (*)	E32 (*)	32.00
ZK65 (*)	E65 (*)	40.00
ZK80 (*)	E80 (*)	56.00
ZK100 (*)	E100 (*)	71.00
ZK150 (*)	E150 (*)	82.00
ZK250 (*)	E250 (*)	144.00
ZK300 (*)	E300 (*)	155.00
ZK500 (*)	E500 (*)	194.00
ZK650 (*)	E650 (*)	204.00
ZK1000 (*)	E1000 (*)	266.00
ZK1250 (*)	E1250 (*)	291.00
ZK1600 (*)	E1600 (*)	389.00

(*) = grade - Example: E15 G order as ZK15 M1
M5 replaces P (5 Micron)
M1 replaces G (1 Micron)
MX replaces H (0.01 Micron & 0.01mg/m³ oil removal)
AC replaces A (Activated Carbon)



Tiger Filtration Ltd

Unit 3, Rivergreen Industry Centre, Pallion, Sunderland, SR4 6AD, UK
Tel: +44 (0) 191 565 5348 Fax: +44 (0) 191 564 0002 Email: sales@tigerfiltration.co.uk