



The Only Real Alternative 2019 Price List (£)

Issue 1 - 01.01.19



Tiger Filtration Ltd - The Only Real Alternative

Contents

	Page
Abac	1
AFE	2
ALMiG	3
Atlas Copco - Current (NEW)	4
Atlas Copco - Current (NEW)	5
Atlas Copco - Previous	6
Atlas Copco - Previous	7
Atlas Copco - Previous	8
Balston (NEW)	9
Bambi (NEW)	10
Bea Filtri - Current (NEW)	11
Bea Filtri - Previous (NEW)	12
Becker	13
BOGE - Current (NEW)	14
BOGE - Previous	15
Busch	16
Ceccato	17
Compair - Current (NEW)	18
Compair - Previous	19
Compair - Previous	20
CTA	21
Deltech	22
Denco	23
Domnick Hunter / Parker	
Oil-X Evolution - Current (NEW)	24
Oil-X Evolution MV - Current (NEW)	25
Oil-X - Previous	26
Oil-X - Previous	27
Oil-X - Previous	28
Oil-X - Previous	29
OVR and Pseudri Silencers (NEW)	30

	Page
DVP	31
Ecoair	32
Edwards	33
Filterworld	34
Friulair T Series - Current	35
Friulair L Series - Previous	36
FST - Current (NEW)	37
Gardner Denver - Separators	38
Gardner Denver (NEW)	39
Hankison NGF - Current (NEW)	40
Hankison - Previous	41
Hi-Line	42
Hiross	43
HPC - Current (NEW)	44
HPC - Previous	45
Hydrovane	46
Hydrovane - Separators	47
Ingersoll Rand - Current (NEW)	48
Ingersoll Rand - Previous	49
Kaeser	50
Leybold	51
Mark	52
Mattei	53
Mattei - Separators	54
MiKROPOR	55
MTA	56
Omega	57
OMI - Current	58
OMI - Previous	59
Pall/PPC	60
Pneumatech	61

Alternative Filter Elements



	Page
Puska	62
PVR	63
Rietschle	64
Sotras	65
Sullair	66
Tepro	67
Ultrafilter / Donaldson	
DF Series - Current (NEW)	68
90 Series - Previous	69
90 Series - Sterile - Previous (NEW)	70
80 Series - Previous	71
80 Series - Sterile - Previous (NEW)	72
Van Air Systems	73
Walker Filtration	
Alpha Series - Current (NEW)	74
Previous	75
Alloy High Pressure	76
Medical Sterile	77
Previous	78
Odasorb (NEW)	79
Autoclave (NEW)	80
Worthington Creyssenac	81
Zander / Parker	
GL Series - Current (NEW)	82
Previous	83
Zeks	84

Quality Products from Tiger Filtration Ltd - Our range of Alternative Elements are designed and manufactured to perform "as good if not better" than the original equipment. All the materials used in the manufacture of these elements are sourced from recognised suppliers to the industry.

We are so confident in our products that we offer a full 12 months "money back" guarantee if you are not happy with the performance.

When you buy a product from **Tiger Filtration Ltd** you get a promise from the Managing Director that the elements are "as good if not better" than the original.



Tiger Filtration Ltd

Unit 3, Rivergreen Industry Centre, Pallion, Sunderland, SR4 6AD, UK

Tel: +44 (0) 191 565 5348 Fax: +44 (0) 191 564 0002

Website: www.tigerfiltration.com Email: sales@tigerfiltration.co.uk



Tiger Filtration Ltd

Abac

Alternative filter elements manufactured by **Tiger Filtration Ltd** to fit into **Abac** filter housings

Alternative Filter Elements



Tiger P/No.	Abac P/No.	List Price £
AB60 (*)	(*) 60	25.00
AB80 (*)	(*) 80	28.00
AB120 (*)	(*) 120	37.00
AB200 (*)	(*) 200	47.00
AB340 (*)	(*) 340	64.00
AB510 (*)	(*) 510	78.00
AB800 (*)	(*) 800	99.00
AB1000 (*)	(*) 1000	135.00
AB1500 (*)	(*) 1500	160.00
AB2400 (*)	(*) 2400	252.00

(*) = grade - Example: APFC60 order as AB60 M1

M3 replaces AQFC (3 Micron)

M1 replaces APFC (1 Micron)

M0 replaces AEFC (0.1 Micron)

MX replaces AHFC (0.01 Micron & 0.01mg/m³ oil removal)

AC replaces ACFC (Activated Carbon)



Tiger Filtration Ltd

Unit 3, Rivergreen Industry Centre, Pallion, Sunderland, SR4 6AD, UK

Tel: +44 (0) 191 565 5348 Fax: +44 (0) 191 564 0002

Website: www.tigerfiltration.com Email: sales@tigerfiltration.co.uk

Tiger Filtration Ltd

Alternative Filter Elements



AFE

Alternative filter elements manufactured by **Tiger Filtration Ltd** to fit into **AFE** filter housings

Tiger P/No.	AFE P/No.	List Price £
AF10 (*)	EA10 (*)	48.00
AF15 (*)	EA15 (*)	59.00
AF20 (*)	EA20 (*)	67.00
AF30 (*)	EA30 (*)	84.00
AF55 (*)	EA55 (*)	111.00
AF95 (*)	EA95 (*)	144.00
AF150 (*)	EA150 (*)	185.00
AF220 (*)	EA220 (*)	229.00
AF290 (*)	EA290 (*)	305.00
AF430 (*)	EA430 (*)	361.00
AF625 (*)	EA625 (*)	509.00
AF775 (*)	EA775 (*)	666.00

(*) = grade - Example: EA10U order as AF10 M1
 M3 replaces P (3 Micron)
 M1 replaces U (1 Micron)
 MX replaces H (0.01 Micron & 0.01mg/m³ oil removal)
 AC replaces C (Activated Carbon)

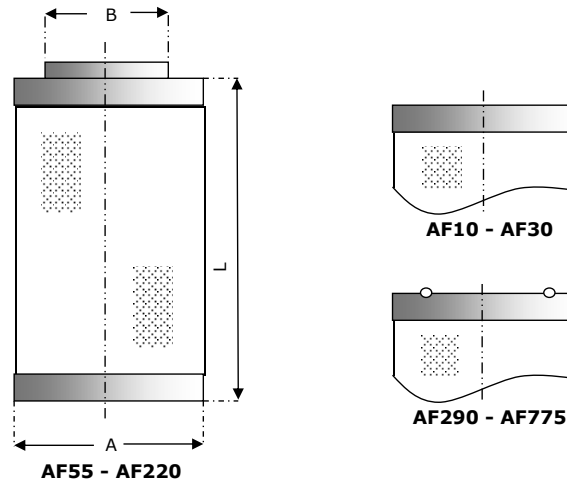

Tiger P/No.	A (mm)	B (mm)	L (mm)
AF10 (*)	51	24 (ID)	50
AF15 (*)	51	24 (ID)	61
AF20 (*)	51	24 (ID)	72
AF30 (*)	51	24 (ID)	140
AF55 (*)	75	63	110
AF95 (*)	75	63	210
AF150 (*)	75	63	310
AF220 (*)	75	63	500
AF290 (*)	91	67 (ID)	509
AF430 (*)	91	67 (ID)	766
AF625 (*)	140	100 (ID)	616
AF775 (*)	140	100 (ID)	751



Tiger Filtration Ltd

Unit 3, Rivergreen Industry Centre, Pallion, Sunderland, SR4 6AD, UK
 Tel: +44 (0) 191 565 5348 Fax: +44 (0) 191 564 0002
 Website: www.tigerfiltration.com Email: sales@tigerfiltration.co.uk

Tiger Filtration Ltd

ALMiG

Alternative filter elements manufactured by **Tiger Filtration Ltd** to fit into **ALMiG** filter housings

Alternative Filter Elements



Tiger P/No.	Almig P/No.	List Price £
AL30 (*)	(*) 30	27.00
AL60 (*)	(*) 60	31.00
AL108 (*)	(*) 108	40.00
AL180 (*)	(*) 180	43.00
AL204 (*)	(*) 204	46.00
AL300 (*)	(*) 300	56.00
AL432 (*)	(*) 432	62.00
AL570 (*)	(*) 570	81.00
AL750 (*)	(*) 750	106.00
AL990 (*)	(*) 990	130.00
AL1140 (*)	(*) 1140	139.00
AL1320 (*)	(*) 1320	181.00

(*) = grade - Example: AFM30 order as AL30 M1

M5 replaces AFP (3 Micron)

M1 replaces AFM (1 Micron)

MX replaces AFS (0.01 Micron & 0.01mg/m³ oil removal)

AC replaces AFC (Activated Carbon)



Tiger Filtration Ltd

Unit 3, Rivergreen Industry Centre, Pallion, Sunderland, SR4 6AD, UK

Tel: +44 (0) 191 565 5348 Fax: +44 (0) 191 564 0002

Website: www.tigerfiltration.com Email: sales@tigerfiltration.co.uk

Tiger Filtration Ltd

Atlas Copco UD+ Nautilus - Current

Alternative filter elements manufactured by **Tiger Filtration Ltd** to fit into **Atlas Copco** filter housings

Alternative Filter Elements



Tiger P/No.	Atlas Copco P/No.	List Price £
AC9-UD	UD9+	91.00
AC15-UD	UD15+	118.00
AC25-UD	UD25+	168.00
AC45-UD	UD45+	193.00
AC60-UD	UD60+	235.00
AC100-UD	UD100+	259.00
AC140-UD	UD140+	283.00
AC180-UD	UD180+	308.00
AC220-UD	UD220+	330.00
AC310-UD	UD310+	437.00
AC425-UD	UD425+	517.00
AC550-UD	UD550+	592.00



Tiger Filtration Ltd

Unit 3, Rivergreen Industry Centre, Pallion, Sunderland, SR4 6AD, UK
Tel: +44 (0) 191 565 5348 Fax: +44 (0) 191 564 0002
Website: www.tigerfiltration.com Email: sales@tigerfiltration.co.uk

Tiger Filtration Ltd

Atlas Copco - Current

Alternative filter elements manufactured by **Tiger Filtration Ltd** to fit into **Atlas Copco** filter housings

Alternative Filter Elements



Grade M1 (DDp+) 1 Micron

Tiger P/No.	Size	AC P/No.	List Price £
AC10-RM1-PL	10+	2901 2003 44	75.00
AC20-RM1-PL	20+	2901 2003 01	99.00
AC35-RM1-PL	35+	2901 2003 02	140.00
AC50-RM1-PL	50+	2901 2003 03	161.00
AC70-RM1-PL	70+	2901 2003 04	196.00
AC130-RM1-PL	130+	2901 2003 05	236.00
AC170-RM1-PL	170+	2901 2003 06	256.00
AC210-RM1-PL	210+	2901 2003 07	275.00
AC310-RM1-PL	310+	2901 2003 08	364.00
AC425-RM1-PL	425+	2901 2003 09	431.00
AC550-RM1-PL	550+	2901 2003 10	493.00
AC850-RM1-PL	850+		441.00

Grade M1 (DD+) 1 Micron

Tiger P/No.	Size	AC P/No.	List Price £
AC10-M1-PL	10+	2901 2003 44	75.00
AC20-M1-PL	20+	2901 2003 01	99.00
AC35-M1-PL	35+	2901 2003 02	140.00
AC50-M1-PL	50+	2901 2003 03	161.00
AC70-M1-PL	70+	2901 2003 04	196.00
AC130-M1-PL	130+	2901 2003 05	236.00
AC170-M1-PL	170+	2901 2003 06	256.00
AC210-M1-PL	210+	2901 2003 07	275.00
AC310-M1-PL	310+	2901 2003 08	364.00
AC425-M1-PL	425+	2901 2003 09	431.00
AC550-M1-PL	550+	2901 2003 10	493.00
AC850-M1-PL	850+		441.00

Grade MX (PD+) 0.01 Micron

Tiger P/No.	Size	AC P/No.	List Price £
AC10-MX-PL	10+	2901 2004 51	75.00
AC20-MX-PL	20+	2901 2004 01	99.00
AC35-MX-PL	35+	2901 2004 02	140.00
AC50-MX-PL	50+	2901 2004 03	161.00
AC70-MX-PL	70+	2901 2004 04	196.00
AC130-MX-PL	130+	2901 2004 05	236.00
AC170-MX-PL	170+	2901 2004 06	256.00
AC210-MX-PL	210+	2901 2004 07	275.00
AC310-MX-PL	310+	2901 2004 08	364.00
AC425-MX-PL	425+	2901 2004 09	431.00
AC550-MX-PL	550+	2901 2004 10	493.00
AC850-MX-PL	850+		441.00

Grade AC (QD+) Activated Carbon

Tiger P/No.	Size	AC P/No.	List Price £
AC10-AC-PL	10+	2901 2005 44	75.00
AC20-AC-PL	20+	2901 2005 01	99.00
AC35-AC-PL	35+	2901 2005 02	140.00
AC50-AC-PL	50+	2901 2005 03	161.00
AC70-AC-PL	70+	2901 2005 04	196.00
AC130-AC-PL	130+	2901 2005 05	236.00
AC170-AC-PL	170+	2901 2005 06	256.00
AC210-AC-PL	210+	2901 2005 07	275.00
AC310-AC-PL	310+	2901 2005 08	364.00
AC425-AC-PL	425+	2901 2005 09	431.00
AC550-AC-PL	550+	2901 2005 10	493.00
AC850-AC-PL	850+		441.00



Tiger Filtration Ltd

Unit 3, Rivergreen Industry Centre, Pallion, Sunderland, SR4 6AD, UK

Tel: +44 (0) 191 565 5348 Fax: +44 (0) 191 564 0002

Website: www.tigerfiltration.com Email: sales@tigerfiltration.co.uk

Tiger Filtration Ltd

Atlas Copco - Previous

Alternative filter elements manufactured by **Tiger Filtration Ltd** to fit into **Atlas Copco** filter housings

Alternative Filter Elements



Grade M1 (DDp) 1 Micron

Tiger P/No.	AC P/No.	List Price £
AC9 M1	2901 0520 00	75.00
AC17 M1	2901 0613 00	99.00
AC32 M1	2901 0526 00	140.00
AC44 M1	2901 0529 00	161.00
AC60 M1	2901 0532 00	196.00
AC120 M1	2901 0535 00	236.00
AC150 M1	2901 0538 00	256.00
AC175 M1	2901 0541 00	275.00
AC260 M1	2901 0544 00	364.00
AC280 M1	2901 0544 00	364.00
AC390 M1	2906 7000 00	431.00
AC520 M1	2906 7003 00	493.00
AC-AX M1	1617 7073 03	403.00

Grade M1 (DD) 1 Micron

Tiger P/No.	AC P/No.	List Price £
AC9 M1	2901 0520 00	75.00
AC17 M1	2901 0613 00	99.00
AC32 M1	2901 0526 00	140.00
AC44 M1	2901 0529 00	161.00
AC60 M1	2901 0532 00	196.00
AC120 M1	2901 0535 00	236.00
AC150 M1	2901 0538 00	256.00
AC175 M1	2901 0541 00	275.00
AC260 M1	2901 0544 00	364.00
AC280 M1	2901 0544 00	364.00
AC390 M1	2906 7000 00	431.00
AC520 M1	2906 7003 00	493.00
AC-AX M1	1617 7073 03	403.00

Grade MX (PD) 0.01 Micron

Tiger P/No.	AC P/No.	List Price £
AC9 MX	2901 0521 00	75.00
AC17 MX	2901 0524 00	99.00
AC32 MX	2901 0527 00	140.00
AC44 MX	2901 0530 00	161.00
AC60 MX	2901 0533 00	196.00
AC120 MX	2901 0536 00	236.00
AC150 MX	2901 0539 00	256.00
AC175 MX	2901 0542 00	275.00
AC260 MX	2901 0545 00	364.00
AC280 MX	2901 0545 00	364.00
AC390 MX	2906 7001 00	431.00
AC520 MX	2906 7004 00	493.00
AC-AX MX	1617 7073 01	403.00

Grade AC (QD) Activated Carbon

Tiger P/No.	AC P/No.	List Price £
AC9 AC	2901 614 00	75.00
AC17 AC	2901 0525 00	99.00
AC32 AC	2901 0528 00	140.00
AC44 AC	2901 0531 00	161.00
AC60 AC	2901 0534 00	196.00
AC120 AC	2901 0537 00	236.00
AC150 AC	2901 0540 00	256.00
AC175 AC	2901 0543 00	275.00
AC260 AC	2901 0546 00	364.00
AC280 AC	2901 0546 00	364.00
AC390 AC	2906 7002 00	431.00
AC520 AC	2906 7005 00	493.00
AC-AX AC	1617 7073 02	403.00



Tiger Filtration Ltd

Unit 3, Rivergreen Industry Centre, Pallion, Sunderland, SR4 6AD, UK
 Tel: +44 (0) 191 565 5348 Fax: +44 (0) 191 564 0002
 Website: www.tigerfiltration.com Email: sales@tigerfiltration.co.uk

Tiger Filtration Ltd

Atlas Copco - Previous

Alternative filter elements manufactured by **Tiger Filtration Ltd** to fit into **Atlas Copco** filter housings

Alternative Filter Elements



Grade M1 (DD) 1 Micron

Tiger P/No.	AC P/No.	List Price £
AC190 M1	2901-0190-00	54.00
AC191 M1	2901-0191-00	84.00
AC234 M1	2901-0234-00	97.00
AC192 M1	2901-0192-00	119.00
AC193 M1	2901-0193-00	155.00
AC194 M1	2901-0194-00	190.00
AC213 M1	2906-0213-00	414.00
AC212 M1	2906-0212-00	315.00

Grade MX (PD) 0.01 Micron

Tiger P/No.	AC P/No.	List Price £
AC195 MX	2901-0195-00	54.00
AC196 MX	2901-0196-00	84.00
AC233 MX	2901-0233-00	97.00
AC197 MX	2901-0197-00	119.00
AC198 MX	2901-0198-00	155.00
AC199 MX	2901-0199-00	190.00
AC215 MX	2906-0215-00	414.00
AC214 MX	2906-0214-00	315.00

Grade AC (QD) Activated Carbon

Tiger P/No.	AC P/No.	List Price £
AC206 AC	2901-0206-00	255.00
AC201 ACC	2901-0201-00	31.00
AC203 ACC	2901-0203-00	49.00
AC235 ACC	2901-0235-00	98.00
AC205 ACC	2901-0205-00	127.00
AC217 AC	2901-0217-00	414.00
AC202 ACC	2901-0202-00	34.00
AC204 ACC	2901-0204-00	70.00
AC216 AC	2906-0216-00	315.00

Grade M1 (DD) 1 Micron

Tiger P/No.	AC P/No.	List Price £
AC625502 M1	1202-6255-02	54.00
AC625702 M1	1202-6257-02	84.00
AC625704 M1	1202-6257-04	97.00
AC625902 M1	1202-6259-02	119.00
AC625904 M1	1202-6259-04	155.00
AC626202 M1	1202-6262-02	190.00
AC857302 M1	1202-8573-02	315.00
AC627302 M1	1202-6273-02	414.00
AC626204 M1	1202-6262-04	248.00

Grade MX (PD) 0.01 Micron

Tiger P/No.	AC P/No.	List Price £
AC625501 MX	1202-6255-01	54.00
AC625701 MX	1202-6257-01	84.00
AC625703 MX	1202-6257-03	97.00
AC625901 MX	1202-6259-01	119.00
AC625903 MX	1202-6259-03	155.00
AC626201 MX	1202-6262-01	190.00
AC857301 MX	1202-8573-01	315.00
AC627301 MX	1202-6273-01	414.00
AC626203 MX	1202-6262-03	248.00

Grade AC (QD) Activated Carbon

Tiger P/No.	AC P/No.	List Price £
AC626400 ACC	1202-6264-00	31.00
AC628101 ACC	1202-6281-01	34.00
AC626801 ACC	1202-6268-01	49.00
AC628102 ACC	1202-6281-02	70.00
AC626802 ACC	1202-6268-02	98.00
AC626803 ACC	1202-6268-03	127.00
AC626301 AC	1202-6263-01	190.00
AC857200 AC	1202-8572-00	315.00
AC627400 AC	1202-6274-00	414.00
AC626302 AC	1202-6263-02	248.00

ACC = AC Element For Duplex Housing



Tiger Filtration Ltd

Unit 3, Rivergreen Industry Centre, Pallion, Sunderland, SR4 6AD, UK

Tel: +44 (0) 191 565 5348 Fax: +44 (0) 191 564 0002

Website: www.tigerfiltration.com Email: sales@tigerfiltration.co.uk

Tiger Filtration Ltd

Atlas Copco - Previous

Alternative filter elements manufactured by **Tiger Filtration Ltd** to fit into **Atlas Copco** filter housings

Alternative Filter Elements



Grade M5 (UFD) 5 Micron

Tiger P/No.	AC P/No.	List Price £
AC925 M5	9703-1925	102.00
AC926 M5	9703-1926	116.00
AC927 M5	9703-1927	150.00
AC928 M5	9703-1928	198.00
AC929 M5	9703-1929	225.00
AC930 M5	9703-1930	294.00
AC931 M5	9703-1931	389.00

Grade M1 (UDD) 1 Micron

Tiger P/No.	AC P/No.	List Price £
AC420 M1	9703-1420	102.00
AC421 M1	9703-1421	116.00
AC422 M1	9703-1422	150.00
AC423 M1	9703-1423	198.00
AC424 M1	9703-1424	225.00
AC425 M1	9703-1425	294.00
AC426 M1	9703-1426	389.00

Grade MX (UPD) 0.01 Micron

Tiger P/No.	AC P/No.	List Price £
AC442 MX	9703-1442	102.00
AC443 MX	9703-1443	116.00
AC444 MX	9703-1444	150.00
AC445 MX	9703-1445	198.00
AC446 MX	9703-1446	225.00
AC447 MX	9703-1447	294.00
AC448 MX	9703-1448	389.00

Grade AC (AC) Activated Carbon

Tiger P/No.	AC P/No.	List Price £
AC431 AC	9703-1431	102.00
AC432 AC	9703-1432	116.00
AC433 AC	9703-1433	150.00
AC434 AC	9703-1434	198.00
AC435 AC	9703-1435	225.00
AC436 AC	9703-1436	294.00
AC437 AC	9703-1437	389.00



Tiger Filtration Ltd

Unit 3, Rivergreen Industry Centre, Pallion, Sunderland, SR4 6AD, UK
 Tel: +44 (0) 191 565 5348 Fax: +44 (0) 191 564 0002
 Website: www.tigerfiltration.com Email: sales@tigerfiltration.co.uk

Tiger Filtration Ltd

Balston

Alternative filter elements manufactured by **Tiger Filtration Ltd** to fit into **Balston** filter housings

Alternative Filter Elements



Tiger P/No.	Balston P/No.	NETT Price £
BL12-25-(*)	050-03-(*)	POA
BL12-32-(*)	050-05-(*)	POA
BL12-57-(*)	050-11-(*)	POA
BL25-51-(*)	100-09-(*)	POA
BL25-64-(*)	100-12-(*)	POA
BL25-127-(*)	100-18-(*)	POA
BL25-178-(*)	100-25-(*)	POA
BL38-152-(*)	150-19-(*)	POA
BL51-89-(*)	200-16-(*)	POA
BL51-213-(*)	200-30-(*)	POA
BL51-230-(*)	200-35-(*)	POA
BL51-460-(*)	200-75-(*)	POA
BL51-476-(*)	200-80-(*)	POA

(*) = grade - Example: 050-03-DX order as BL12-25-70C

AVAILABLE IN PACKS OF 3 OR 10 ONLY

Balston Grade	Tiger Grade
N/A	80C
DX	70C
CX	60C
BX	50C
DXE	70CE
CXE	60CE
BXE	50CE
N/A	80K
DQ	70K
CQ	60K
BQ	50K
AQ	40K
AAQ	30K
N/A	80S
DH	70S
CH	60S
BH	50S
AH	40S
AAH	30S
N/A	80
D	70
C	60
B	50
A	40
AA	30
371H	50CS
DH21	70S21-R
R	70ZZ
SA	40L
30	70RC
290	60
404	60W



Tiger Filtration Ltd

Unit 3, Rivergreen Industry Centre, Pallion, Sunderland, SR4 6AD, UK
 Tel: +44 (0) 191 565 5348 Fax: +44 (0) 191 564 0002
 Website: www.tigerfiltration.com Email: sales@tigerfiltration.co.uk

Tiger Filtration Ltd

Bambi

Alternative filter elements manufactured by **Tiger Filtration Ltd** to fit into **Bambi** filter housings

Tiger P/No.	Bambi P/No.	NETT Price £
BM1131-MX	BPB1131A	21.00
BM1131-AC	BPB1131	21.00
BM0171-MX	BPB0171	21.00
BM0170-AC	BPB0170	21.00

MX = 0.01 Micron & 0.01mg/m³ oil removal
AC = Activated Carbon

Alternative Filter Elements



Tiger Filtration Ltd

Unit 3, Rivergreen Industry Centre, Pallion, Sunderland, SR4 6AD, UK
Tel: +44 (0) 191 565 5348 Fax: +44 (0) 191 564 0002
Website: www.tigerfiltration.com Email: sales@tigerfiltration.co.uk

Tiger Filtration Ltd

Bea Filtri - AIR VIP Range - Current

Alternative air/oil separator elements manufactured by **Tiger Filtration Ltd** to fit into **Bea Filtri** filter housings

Alternative Filter Elements



Tiger P/No.	Bea Filtri P/No.	NETT Price £
BF15-(*)	ARS 15 (*)	15.00
BF30-(*)	ARS 30 (*)	18.00
BF100-(*)	ARS 100 (*)	30.00
BF180-(*)	ARS 180 (*)	38.00
BF290-(*)	ARS 290 (*)	42.00
BF460-(*)	ARS 460 (*)	57.00
BF610-(*)	ARS 610 (*)	68.00
BF930-(*)	ARS 930 (*)	82.00
BF1050-(*)	ARS 1050 (*)	99.00
BF1250-(*)	ARS 1250 (*)	101.00
BF1400-(*)	ARS 1400 (*)	105.00
BF2300-(*)	ARS 2300 (*)	136.00

(*) = grade - Example: ARS 15 RM order as BF15-M10
M10 replaces RM (10 Micron)
M1 replaces RB (1 Micron)
RM1 replaces RF (1 Micron Dust Filter)
MX replaces RA (0.01 Micron & 0.01mg/m³ oil removal)
AC replaces CA (Activated Carbon)



Tiger Filtration Ltd

Unit 3, Rivergreen Industry Centre, Pallion, Sunderland, SR4 6AD, UK
Tel: +44 (0) 191 565 5348 Fax: +44 (0) 191 564 0002
Website: www.tigerfiltration.com Email: sales@tigerfiltration.co.uk

Tiger Filtration Ltd

Bea Filtri - AIR top Range - Previous

Alternative air/oil separator elements manufactured by **Tiger Filtration Ltd** to fit into **Bea Filtri** filter housings

Alternative Filter Elements



Tiger P/No.	Bea Filtri P/No.	NETT Price £
BF0501 (*)	FCY 0501 (*)	21.00
BF1001 (*)	FCY 1001 (*)	31.00
BF2001 (*)	FCY 2001 (*)	42.00
BF2501 (*)	FCY 2501 (*)	44.00
BF3001 (*)	FCR 3001 (*)	71.00
BF4001 (*)	FCR 4001 (*)	89.00
BF4002 (*)	FCR 4002 (*)	147.00

(*) = grade - Example: FCY 0501 RM order as BF0501-M10

M3 replaces RC (3 Micron)

M1 replaces RB (1 Micron)

RM1 replaces RF (1 Micron Dust Filter)

MX replaces RA (0.01 Micron & 0.01mg/m³ oil removal)

AC replaces CA (Activated Carbon)



Tiger Filtration Ltd

Unit 3, Rivergreen Industry Centre, Pallion, Sunderland, SR4 6AD, UK

Tel: +44 (0) 191 565 5348 Fax: +44 (0) 191 564 0002

Website: www.tigerfiltration.com Email: sales@tigerfiltration.co.uk

Tiger Filtration Ltd

Becker

Alternative air/oil separator elements manufactured by **Tiger Filtration Ltd** to fit into **Becker** vacuum pumps

Alternative Filter Elements



Tiger P/No.	Becker P/No.	List Price £
BK100 MF	6540100	27.00
BK402 MF	965402	61.00
BK403 MF	965403	72.00
BK404 MF	965404	32.00
BK406 MF	965406	74.00
BK409 MF	965409	49.00
BK410 MF	965410	185.00
BK411 MF	965411	226.00
BK412 MF	965412	49.00
BK413 MF	965413	36.00
BK414 MF	965414	35.00
BK415 MF	965415	46.00
BK416 MF	965416	44.00



Tiger Filtration Ltd

Unit 3, Rivergreen Industry Centre, Pallion, Sunderland, SR4 6AD, UK
Tel: +44 (0) 191 565 5348 Fax: +44 (0) 191 564 0002
Website: www.tigerfiltration.com Email: sales@tigerfiltration.co.uk

Tiger Filtration Ltd

Boge HP Series - Current

Alternative filter elements by **Tiger Filtration Ltd** to fit into **Boge HP** filter housings

Alternative Filter Elements



Tiger P/No.	BOGE P/No.	NETT Price £
BG6 (*)	F6 (*)	21.00
BG9-12 (*)	F9 & F12 (*)	31.00
BG18 (*)	F18 (*)	37.00
BG36 (*)	F36 (*)	44.00
BG65 (*)	F65 (*)	54.00
BG95 (*)	F95 (*)	60.00
BG130 (*)	F130 (*)	67.00
BG190 (*)	F190 (*)	100.00
BG260 (*)	F260 (*)	119.00
BG380 (*)	F380 (*)	163.00

(*) = grade - Example: F6 P order as BG6 M1

M1 replaces P (1 Micron)

MX replaces M (0.01 Micron & 0.01mg/m³ oil removal)

AC replaces A (Activated Carbon)



Tiger Filtration Ltd

Unit 3, Rivergreen Industry Centre, Pallion, Sunderland, SR4 6AD, UK

Tel: +44 (0) 191 565 5348 Fax: +44 (0) 191 564 0002

Website: www.tigerfiltration.com Email: sales@tigerfiltration.co.uk

Tiger Filtration Ltd

Boge - Previous

Alternative filter elements manufactured by **Tiger Filtration Ltd** to fit into **Boge** filter housings

Alternative Filter Elements



Tiger P/No.	BOGE P/No.	List Price £
BG5 (*)	1/5 (*)	65.00
BG10 (*)	1/10 (*)	78.00
BG12 (*)	1/12 (*)	91.00
BG20 (*)	1/20 (*)	112.00
BG30 (*)	1/30 (*)	147.00
BG50 (*)	1/50 (*)	190.00
BG80 (*)	1/80 (*)	236.00
BG120 (*)	1/120 (*)	305.00
BG160 (*)	1/160 (*)	359.00
BG250 (*)	1/250 (*)	420.00
BG400 (*)	1/400 (*)	697.00

(*) = grade - Example: 1/5 V order as BG5 M3
M3 replaces V (3 Micron)
MX replaces FP (0.01 Micron)
AC replaces A (Activated Carbon)



Tiger Filtration Ltd

Unit 3, Rivergreen Industry Centre, Pallion, Sunderland, SR4 6AD, UK
Tel: +44 (0) 191 565 5348 Fax: +44 (0) 191 564 0002
Website: www.tigerfiltration.com Email: sales@tigerfiltration.co.uk

Tiger Filtration Ltd

Busch

Alternative air/oil separator elements manufactured by **Tiger Filtration Ltd** to fit into **Busch** vacuum pumps

Alternative Filter Elements



Grade MF			Without Silencer
Tiger P/No.	Busch P/No.	O. D. Length	List Price £
BU101 MF	532-101	52mm/230mm	40.00
BU151 MF	532-151	35mm/56mm	19.00
BU216 MF	532-216	54mm/120mm	27.00
BU222 MF	532-222	54mm/200mm	27.00
BU221 MF	532-221	72mm/130mm	27.00
BU301 MF	532-301	52mm/230mm	40.00
BU302 MF	532-302	72mm/250mm	33.00
BU303 MF	532-303	72mm/375mm	50.00
BU304 MF	532-304	72mm/500mm	67.00

Grade MFS			With Silencer
Tiger P/No.	Busch P/No.	O. D. Length	List Price £
BU510 MFS	532-510	72mm/130mm	32.00
BU509 MFS	532-509	72mm/250mm	38.00
BU508 MFS	532-508	72mm/375mm	57.00
BU507 MFS	532-507	72mm/500mm	73.00
BU512 MFS	532-512	72mm/208mm	35.00

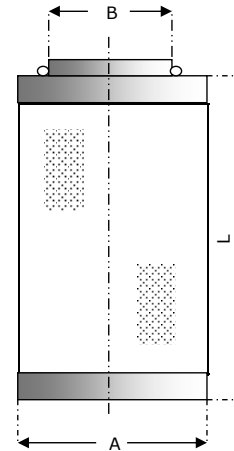

Tiger P/No.	A (mm)	B (mm)	L (mm)
BU101 MF	52	M22 thread	230
BU151 MF	35	3/8 BSP	56
BU216 MF	54	29	120
BU222 MF	54	29	200
BU221 MF	72	35	130
BU301 MF	52	M22 thread	230
BU302 MF	72	35	250
BU303 MF	72	35	375
BU304 MF	72	35	500
BU510 MFS	72	35	130
BU509 MFS	72	35	250
BU508 MFS	72	35	375
BU507 MFS	72	35	500
BU512 MFS	72	35	208



Tiger Filtration Ltd

Unit 3, Rivergreen Industry Centre, Pallion, Sunderland, SR4 6AD, UK

Tel: +44 (0) 191 565 5348 Fax: +44 (0) 191 564 0002

Website: www.tigerfiltration.com Email: sales@tigerfiltration.co.uk

Tiger Filtration Ltd

Ceccato

Alternative filter elements manufactured by **Tiger Filtration Ltd** to fit into **Ceccato** filter housings

Alternative Filter Elements



Tiger P/No.	Ceccato P/No.	List Price £
CE10 (*)	10 (*)	37.00
CE13 (*)	13 (*)	46.00
CE20 (*)	20 (*)	58.00
CE33 (*)	33 (*)	72.00
CE60 (*)	60 (*)	98.00
CE85 (*)	85 (*)	117.00
CE130 (*)	130 (*)	148.00
CE170 (*)	170 (*)	182.00
CE250 (*)	250 (*)	208.00
CE400 (*)	400 (*)	299.00

(*) = grade - Example: 10FPRE order as CE10 M1
M3 replaces FPRO (3 Micron)
M1 replaces FPRE (1 Micron)
M0 replaces FMO (0.1 Micron)
MX replaces FMM (0.01 Micron)
AC replaces FCA (Activated Carbon)



Tiger Filtration Ltd

Unit 3, Rivergreen Industry Centre, Pallion, Sunderland, SR4 6AD, UK
Tel: +44 (0) 191 565 5348 Fax: +44 (0) 191 564 0002
Website: www.tigerfiltration.com Email: sales@tigerfiltration.co.uk

Tiger Filtration Ltd

Compair CF_N Style Evolution - Current

Alternative filter elements by **Tiger Filtration Ltd** to fit into **Compair** CF_N Evolution Style filter housings

Alternative Filter Elements



Tiger P/No.	Compair P/No.	List Price £
CP0006 (*)-N	CE0006N (*)	46.00
CP0012 (*)-N	CE0012N (*)	73.00
CP0018 (*)-N	CE0018N (*)	85.00
CP0036 (*)-N	CE0036N (*)	103.00
CP0066 (*)-N	CE0066N (*)	121.00
CP0096 (*)-N	CE0096N (*)	138.00
CP0132 (*)-N	CE0132N (*)	163.00
CP0198 (*)-N	CE0198N (*)	233.00
CP0258 (*)-N	CE0258N (*)	275.00
CP0372 (*)-N	CE0372N (*)	369.00

Multi-Element

CP0600 (*)-N	CE0600N (*)	233.00
--------------	-------------	--------

(*) = grade - Example: CE0006N B order as CP0006 M1-N
M1 replaces B (1 Micron)
MX replaces C (0.01 Micron)
RM1 replaces E (1 Micron Dust Removal)
RMX replaces F (0.01 Micron Dust Removal)
AC replaces D (Activated Carbon)



Tiger Filtration Ltd

Unit 3, Rivergreen Industry Centre, Pallion, Sunderland, SR4 6AD, UK
Tel: +44 (0) 191 565 5348 Fax: +44 (0) 191 564 0002
Website: www.tigerfiltration.com Email: sales@tigerfiltration.co.uk

Tiger Filtration Ltd

Compair - Previous

Alternative filter elements manufactured by **Tiger Filtration Ltd** to fit into **Compair** filter housings

Alternative Filter Elements



Tiger P/No.	Compair P/No.	List Price £
CP0005 (*)	CE0005 (*)	46.00
CP0010 (*)	CE0010 (*)	72.00
CP0018 (*)	CE0018 (*)	83.00
CP0036 (*)	CE0036 (*)	110.00
CP0087 (*)	CE0087 (*)	141.00
CP0132 (*)	CE0132 (*)	161.00
CP0198 (*)	CE0198 (*)	218.00
CP0258 (*)	CE0258 (*)	293.00
CP0372 (*)	CE0372 (*)	370.00

(*) = grade - Example: CE0005 B order as CP0005 M1

M25 replaces A (25 Micron)

M1 replaces B & E (1 Micron)

MX replaces C (0.01 Micron)

AC replaces D (Activated Carbon) - Single Stage Filter Housing

Grade ACC

Activated Carbon

Tiger P/No.	Compair P/No.	List Price £
CP0004 ACC	CE0004 D	34.00
CP0008 ACC	CE0008 D	37.00
CP0015 ACC	CE0015 D	50.00
CP0024 ACC	CE0024 D	70.00
CP0039 ACC	CE0039 D	123.00
CP0051 ACC	CE0051 D	155.00

ACC = AC Element For Duplex Housing



Tiger Filtration Ltd

Unit 3, Rivergreen Industry Centre, Pallion, Sunderland, SR4 6AD, UK

Tel: +44 (0) 191 565 5348 Fax: +44 (0) 191 564 0002

Website: www.tigerfiltration.com Email: sales@tigerfiltration.co.uk

Tiger Filtration Ltd

Compair - Previous

Alternative filter elements manufactured by **Tiger Filtration Ltd** to fit into **Compair** filter housings

Grade M1(GPP) 1 Micron		
Tiger P/No.	Comp P/No.	List Price £
CP21 M1	98245/121	40.00
CP22 M1	98245/122	67.00
CP23 M1	98245/123	78.00
CP25 M1	98245/125	97.00
CP26 M1	98245/126	127.00
CP27 M1	98245/127	151.00
CP28 M1	98245/128	218.00
CP29 M1	98245/129	349.00
CP30 M1	98245/130	258.00

Grade MX(OFP) 0.01 Micron		
Tiger P/No.	Comp P/No.	List Price £
CP41 MX	98245/141	40.00
CP42 MX	98245/142	67.00
CP43 MX	98245/143	78.00
CP45 MX	98245/145	97.00
CP46 MX	98245/146	127.00
CP47 MX	98245/147	151.00
CP48 MX	98245/148	218.00
CP49 MX	98245/149	349.00
CP50 MX	98245/150	258.00

Grade AC(OVR) Activated Carbon		
Tiger P/No.	Comp P/No.	List Price £
CP61 ACC	98245/161	34.00
CP62 ACC	98245/162	37.00
CP63 ACC	98245/163	50.00
CP64 ACC	98245/164	123.00
CP65 ACC	98245/165	70.00
CP66 ACC	98245/166	155.00
CP67 AC	98245/167	151.00
CP68 AC	98245/168	218.00
CP69 AC	98245/169	349.00
CP70 AC	98245/170	258.00

Grade M1(GPP) 1 Micron		
Tiger P/No.	Comp P/No.	List Price £
CP22 M1	98245/21	67.00
CP23 M1	98245/22	78.00
CP25 M1	98245/23	97.00
CP26 M1	98245/25	127.00
CP27 M1	98245/27	151.00
CP28 M1	98245/28	218.00
CP29 M1	98245/29	349.00

Grade MX(OFP) 0.01 Micron		
Tiger P/No.	Comp P/No.	List Price £
CP42 MX	98245/41	67.00
CP43 MX	98245/42	78.00
CP45 MX	98245/43	97.00
CP46 MX	98245/45	127.00
CP47 MX	98245/47	151.00
CP48 MX	98245/48	218.00
CP49 MX	98245/49	349.00

Grade AC(OVR) Activated Carbon		
Tiger P/No.	Comp P/No.	List Price £
CP62 ACC	98245/62	37.00
CP65 ACC	98245/65	70.00
CP67 AC	98245/67	151.00
CP68 AC	98245/68	218.00

ACC = AC Element For Duplex Housing



Tiger Filtration Ltd

Unit 3, Rivergreen Industry Centre, Pallion, Sunderland, SR4 6AD, UK
 Tel: +44 (0) 191 565 5348 Fax: +44 (0) 191 564 0002
 Website: www.tigerfiltration.com Email: sales@tigerfiltration.co.uk

Tiger Filtration Ltd

C.T.A.

Alternative filter elements manufactured by **Tiger Filtration Ltd** to fit into **C.T.A.** filter housings

Alternative Filter Elements



Tiger P/No.	CTA P/No.	List Price £
CT5050 (*)	05050 (*)	36.00
CT6050 (*)	06050 (*)	41.00
CT7050 (*)	07050 (*)	48.00
CT14050 (*)	14050 (*)	61.00
CT12075 (*)	12075 (*)	78.00
CT22075 (*)	22075 (*)	101.00
CT32075 (*)	32075 (*)	125.00
CT50075 (*)	50075 (*)	160.00
CT51090 (*)	51090 (*)	193.00
CT76090 (*)	76090 (*)	222.00
CT75140 (*)	75140 (*)	315.00

(*) = grade - Example: 05050 M order as CT5050 M1
 M3 replaces P (3 Micron)
 M1 replaces M (1 Micron)
 MX replaces S (0.01 Micron)
 AC replaces A (Activated Carbon)

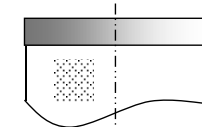
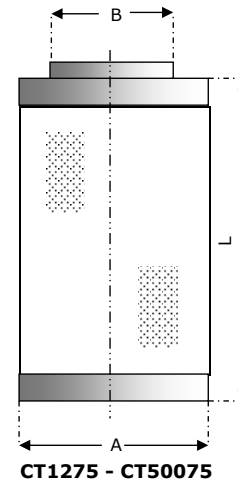

CT5050 - CT14050

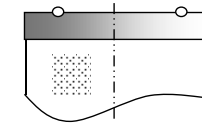

CT51090 & CT75140

Tiger P/No.	A (mm)	B (mm)	L (mm)
CT5050 (*)	51	24 (ID)	50
CT6050 (*)	51	24 (ID)	61
CT7050 (*)	51	24 (ID)	72
CT14050 (*)	51	24 (ID)	140
CT12075 (*)	75	63	119
CT22075 (*)	75	63	219
CT32075 (*)	75	63	319
CT50075 (*)	75	63	500
CT51090 (*)	91	67 (ID)	509
CT76090 (*)	91	67 (ID)	766
CT75140 (*)	140	100 (ID)	751



Tiger Filtration Ltd

Unit 3, Rivergreen Industry Centre, Pallion, Sunderland, SR4 6AD, UK
 Tel: +44 (0) 191 565 5348 Fax: +44 (0) 191 564 0002
 Website: www.tigerfiltration.com Email: sales@tigerfiltration.co.uk

Tiger Filtration Ltd

Deltech

Alternative filter elements manufactured for **Tiger Filtration Ltd** to fit into **Deltech** filter housings

Alternative Filter Elements



Tiger P/No.	Deltech P/No.	NETT Price £
DE9 (*)	(*) D 9	25.00
DE18 (*)	(*) D 18	37.00
DE36 (*)	(*) D 36	51.00
DE54 (*)	(*) D 54	58.00
DE90 (*)	(*) D 90	62.00
DE135 (*)	(*) D 135	68.00
DE216 (*)	(*) D 216	125.00
DE285 (*)	(*) D 285	134.00
DE405 (*)	(*) D 405	150.00
DE540 (*)	(*) D 540	181.00
DE750 (*)	(*) D 750	238.00

Tiger P/No.	Deltech P/No.	NETT Price £
DE811	811 E	40.00
DE812	812 E	46.00
DE813	813 E	65.00
DE814	814 E	84.00
DE815	815 E	106.00
DE816	816 E	134.00
DE817	817 E	185.00
DE818	818 E	210.00
DE819	819 E	250.00
DE820	820 E	254.00

Tiger P/No.	Deltech P/No.	NETT Price £
DE850 (*)	850 (*)	31.00
DE851 (*)	851 (*)	31.00
DE852 (*)	852 (*)	48.00
DE870 (*)	870 (*)	60.00
DE871 (*)	871 (*)	60.00
DE872 (*)	872 (*)	70.00
DE8101 (*)	101 (*)	118.00
DE8102 (*)	102 (*)	118.00
DE8111 (*)	111 (*)	133.00
DE8113 (*)	113 (*)	146.00
DE8201 (*)	201 (*)	177.00
DE8202 (*)	202 (*)	219.00
DE8113 (*)	113 (*)	146.00

Tiger P/No.	Deltech P/No.	NETT Price £
DE830 (*)	830E (*)	172.00
DE831 (*)	831E (*)	172.00

(*) = grade - Example: GFD 9 order as DE9 M10
M10 replaces GFD (10 Micron)
M1 replaces PFD & DFD (1 Micron)
MX replaces HFD (0.01 Micron & 0.01mg/m³ oil removal)
AC replaces CFD (Activated Carbon)



Tiger Filtration Ltd

Unit 3, Rivergreen Industry Centre, Pallion, Sunderland, SR4 6AD, UK
Tel: +44 (0) 191 565 5348 Fax: +44 (0) 191 564 0002
Website: www.tigerfiltration.com Email: sales@tigerfiltration.co.uk

Tiger Filtration Ltd

Denco

Alternative filter elements manufactured by **Tiger Filtration Ltd** to fit into **Denco** filter housings

Alternative Filter Elements



Tiger P/No.	Denco P/No.	List Price £
DTFW12 (*)	(*)DC12	57.00
DTFW15 (*)	(*)DC15	57.00
DTFW17 (*)	(*)DC17	65.00
DTFW22 (*)	(*)DC22	75.00
DTFW23 (*)	(*)DC23	80.00
DTFW32 (*)	(*)DC32	85.00
DTFW42 (*)	(*)DC42	96.00
DTFW44 (*)	(*)DC44	105.00
DTFW52 (*)	(*)DC52	115.00
DTFW62 (*)	(*)DC62	209.00
DTFW64 (*)	(*)DC64	232.00
DTFW72 (*)	(*)DC72	268.00
DTFW82 (*)	(*)DC82	293.00
DTFW85 (*)	(*)DC85	317.00

(*) = grade - Example: 01DC12 order as DTFW12 M1
M5 replaces 05 (5 Micron)
M1 replaces 01 (1 Micron)
MX replaces 00 (0.01 Micron & 0.01mg/m³ oil removal)
AC stays as AC (Activated Carbon)



Tiger Filtration Ltd

Unit 3, Rivergreen Industry Centre, Pallion, Sunderland, SR4 6AD, UK
Tel: +44 (0) 191 565 5348 Fax: +44 (0) 191 564 0002
Website: www.tigerfiltration.com Email: sales@tigerfiltration.co.uk

Tiger Filtration Ltd

Domnick Hunter (Parker) Oil-X Evolution 2005 to 2016 - Current

Alternative filter elements by **Tiger Filtration Ltd** to fit into **Domnick Hunter (Parker)** Evolution filter housings

Alternative Filter Elements



Tiger P/No.	DH P/No.	List Price £
DH005 (*)-N	005 (*)	43.00
DH010 (*)-N	010 (*)	46.00
DH015 (*)-N	015 (*)	73.00
DH020 (*)-N	020 (*)	85.00
DH025 (*)-N	025 (*)	103.00
DH030 (*)-N	030 (*)	121.00
DH035 (*)-N	035 (*)	138.00
DH040 (*)-N	040 (*)	163.00
DH045 (*)-N	045 (*)	233.00
DH050 (*)-N	050 (*)	275.00
DH055 (*)-N	055 (*)	369.00
DH100 (*)-N	100 (*)	162.00

Multi-Element

DH060 (*)-N	060 (*)	233.00
-------------	---------	--------

Tiger P/No.	DH P/No.	NETT Price £
DH150 (*)-N	150 (*)	115.00
DH200 (*)-N	200 (*)	157.00

Tiger P/No.	DH P/No.	NETT Price £
DH010 ACC	010AC	21.00
DH015 ACC-N	015AC	26.00
DH020 ACC-N	020AC	33.00
DH025 DACC	025DAC	52.00
DH025 EACC	025EAC	52.00
DH030 ACC-N	030AC	102.00

ACC = AC Element for Duplex Housing

(*) = grade - Example: 005AO order as DH005 M1-N

M1 replaces AO (1 Micron)

MX replaces AA (0.01 Micron)

RM1 replaces AR (1 Micron Dust Removal)

RMX replaces AAR (0.01 Micron Dust Removal)

AC replaces ACS (Activated Carbon) - Single Stage



Tiger Filtration Ltd

Unit 3, Rivergreen Industry Centre, Pallion, Sunderland, SR4 6AD, UK

Tel: +44 (0) 191 565 5348 Fax: +44 (0) 191 564 0002

Website: www.tigerfiltration.com Email: sales@tigerfiltration.co.uk

Tiger Filtration Ltd

Alternative Filter Elements

Domnick Hunter (Parker) Medical Vacuum Oil-X Evolution 2005 (MV)

Alternative filter elements by **Tiger Filtration Ltd** to fit into **Domnick Hunter (Parker)** Evolution filter housings



Tiger P/No.	DH P/No.	List Price £
DH005 MV-N	005 MV	45.00
DH010 MV-N	010 MV	46.00
DH015 MV-N	015 MV	72.00
DH020 MV-N	020 MV	83.00
DH025 MV-N	025 MV	103.00
DH030 MV-N	030 MV	120.00
DH035 MV-N	035 MV	137.00
DH040 MV-N	040 MV	162.00
DH045 MV-N	045 MV	229.00
DH050 MV-N	050 MV	266.00
DH055 MV-N	055 MV	360.00
DH060 MV-N	060 MV	235.00

Example: 005 MV order as DH005-MV-N



Tiger Filtration Ltd

Unit 3, Rivergreen Industry Centre, Pallion, Sunderland, SR4 6AD, UK
Tel: +44 (0) 191 565 5348 Fax: +44 (0) 191 564 0002
Website: www.tigerfiltration.com Email: sales@tigerfiltration.co.uk

Tiger Filtration Ltd

Alternative Filter Elements

Domnick Hunter (Parker) Oil-X 0009G to 1000G - Previous

Alternative filter elements manufactured by **Tiger Filtration Ltd** to fit into **Domnick Hunter (Parker)** filter housings



Tiger P/No.	DH P/No.	List Price £
DH009 (*)	K009 (*)	40.00
DH017 (*)	K017 (*)	67.00
DH030 (*)	K030 (*)	78.00
DH058 (*)	K058 (*)	97.00
DH145 (*)	K145 (*)	127.00
DH220 (*)	K220 (*)	151.00
DH330 (*)	K330 (*)	218.00
DH430 (*)	K430 (*)	258.00
DH620 (*)	K620 (*)	349.00

(*) = grade - Example: K009 AO order as DH009 M1
 M25 replaces PF (25 Micron)
 M1 replaces AO (1 Micron)
 MX replaces AA (0.01 Micron & 0.01mg/m³ oil removal)
 MXX replaces AX (0.01 Micron & 0.001mg/m³ oil removal)
 AC replaces ACS (Activated Carbon) - Single Stage Filter Housing

Grade ACC		Activated Carbon	List Price £
Tiger P/No.	DH P/No.		
DH006 ACC	K006 AC		24.00
DH013 ACC	K013 AC		32.00
DH025 ACC	K025 AC		44.00
DH040 ACC	K040 AC		66.00
DH065 ACC	K065 AC		100.00
DH085 ACC	K085 AC		137.00

ACC = AC Element For Duplex Housing



Tiger Filtration Ltd

Unit 3, Rivergreen Industry Centre, Pallion, Sunderland, SR4 6AD, UK
 Tel: +44 (0) 191 565 5348 Fax: +44 (0) 191 564 0002
 Website: www.tigerfiltration.com Email: sales@tigerfiltration.co.uk

Tiger Filtration Ltd

Alternative Filter Elements

Domnick Hunter (Parker) - Previous

Alternative filter elements manufactured by **Tiger Filtration Ltd** to fit into **Domnick Hunter (Parker)** filter housings



Tiger P/No.	DH P/No.	List Price £
DH006 (*)	K006 (*)	40.00
DH013 (*)	K013 (*)	67.00
DH025 (*)	K025 (*)	78.00
DH040 (*)	K040 (*)	97.00
DH085 (*)	K085 (*)	127.00
DH195 (*)	K195 (*)	151.00
DH295 (*)	K295 (*)	218.00
DH400 (*)	K400 (*)	258.00
DH500 (*)	K500 (*)	349.00

(*) = grade - Example: K006 AO order as DH006 M1

M25 replaces PF (25 Micron)

M1 replaces AO (1 Micron)

MX replaces AA (0.01 Micron & 0.01mg/m³ oil removal)

MXX replaces AX (0.01 Micron & 0.001mg/m³ oil removal)

AC replaces ACS with the exception of K006 AC which is replaced by DH006 ACC



Tiger Filtration Ltd

Unit 3, Rivergreen Industry Centre, Pallion, Sunderland, SR4 6AD, UK

Tel: +44 (0) 191 565 5348 Fax: +44 (0) 191 564 0002

Website: www.tigerfiltration.com Email: sales@tigerfiltration.co.uk

Tiger Filtration Ltd

Domnick Hunter (Parker) - Previous

Alternative filter elements manufactured by **Tiger Filtration Ltd** to fit into **Domnick Hunter (Parker)** filter housings

Alternative Filter Elements



Tiger P/No.	DH P/No.	List Price £
DH007 (*)	E007 (*)	67.00
DH011 (*)	E011 (*)	78.00
DH035 (*)	E035 (*)	89.00
DH060 (*)	E060 (*)	100.00
DH120 (*)	E120 (*)	148.00
DH200 (*)	E200 (*)	212.00
DH250 (*)	E250 (*)	212.00
DH300 (*)	E300 (*)	335.00
DH360 (*)	E360 (*)	335.00

Grade AC		Activated Carbon
Tiger P/No.	DH P/No.	List Price £
DH011 ACC	ABN 1	46.00
DH011 ACC	E011 AC	46.00
DH060 ACC	E060 AC	68.00
DH120 AC	E120 AC	148.00
DH200 AC	E200 AC	212.00
DH250 AC	E250 AC	212.00
DH300 AC	E300 AC	335.00
DH360 AC	E360 AC	335.00

ACC = AC Element For Duplex Housing

(*) = grade - Example: E007 AO order as DH007 M1
 M25 replaces PF (25 Micron)
 M1 replaces AO (1 Micron)
 MX replaces AA (0.01 Micron & 0.01mg/m³ oil removal)

Tiger P/No.	DH P/No.	List Price £
DH007 (*)	E007 (*)	67.00
DH011 (*)	E011 (*)	78.00
DH035 (*)	E035 (*)	89.00
DH060 (*)	E060 (*)	100.00
DH085 (*)	E085 (*)	100.00
DH120 (*)	E120 (*)	148.00
DH195 (*)	E195 (*)	148.00
DH200 (*)	E200 (*)	212.00
DH250 (*)	E250 (*)	212.00
DH295 (*)	E295 (*)	218.00
DH300 (*)	E300 (*)	335.00
DH360 (*)	E360 (*)	335.00
DH500 (*)	E500 (*)	349.00

(*) = grade - Example: E007 AOTS order as DH007 M1
 M1 replaces AOTS (1 Micron)
 MX replaces AATS (0.01 Micron)



Tiger Filtration Ltd

Unit 3, Rivergreen Industry Centre, Pallion, Sunderland, SR4 6AD, UK
 Tel: +44 (0) 191 565 5348 Fax: +44 (0) 191 564 0002
 Website: www.tigerfiltration.com Email: sales@tigerfiltration.co.uk

Tiger Filtration Ltd

Alternative Filter Elements

Domnick Hunter (Parker) - Oil-X Medical Vacuum - Previous

Alternative filter elements manufactured by **Tiger Filtration Ltd** to fit into **Domnick Hunter (Parker)** filter housings



Tiger P/No.	DH P/No.	List Price £
DH025 MV	K025 PL	98.00
DH040 MV	K040 PL	114.00
DH085 MV	K085 PL	140.00
DH195 MV	K195 PL	191.00
DH400 MV	K400 PL	386.00



Tiger Filtration Ltd

Unit 3, Rivergreen Industry Centre, Pallion, Sunderland, SR4 6AD, UK
Tel: +44 (0) 191 565 5348 Fax: +44 (0) 191 564 0002
Website: www.tigerfiltration.com Email: sales@tigerfiltration.co.uk

Tiger Filtration Ltd

Alternative Filter Elements

Domnick Hunter (Parker) - OVR and Pseudri Silencers

Alternative OVR and Dryer Exhaust Silencers manufactured by **Tiger Filtration Ltd** to fit into **Domnick Hunter (Parker)** equipment



Alternative Oil-X Evolution OVR Cartridges

Tiger P/No.	DH P/No.	Model	Quantity	NETT Price Each £
DH100OVR	100OVR	OVR100E	1	198.00
DH100OVR	100OVR	OVR150H	2	198.00
DH100OVR	100OVR	OVR200H	4	198.00
DH100OVR	100OVR	OVR250J	6	198.00
DH100OVR	100OVR	OVR250J x 2 (*)	12	198.00
DH100OVR	100OVR	OVR250J x 3 (*)	18	198.00
DH100OVR	100OVR	OVR250J x 4 (*)	24	198.00
DH100OVR	100OVR	OVR250J x 5 (*)	30	198.00
DH100OVR	100OVR	OVR250J x 6 (*)	36	198.00
DH100OVR	100OVR	OVR250J x 7 (*)	42	198.00
DH100OVR	100OVR	OVR250J x 8 (*)	48	198.00
DH100OVR	100OVR	OVR250J x 9 (*)	54	198.00
DH100OVR	100OVR	OVR250J x 10 (*)	60	198.00
DH300OVR	300OVR	OVR300H	1	240.00

(*) = number of OVR banks

Alternative Pseudri Silencer Service Kits

Tiger P/No.	DH P/No.	Model	Quantity	NETT Price Each £
DH608250500	60 825 0500		KIT OF 2	100.00
DH608620090	60 862 0090		KIT OF 1	86.00



Tiger Filtration Ltd

Unit 3, Rivergreen Industry Centre, Pallion, Sunderland, SR4 6AD, UK
 Tel: +44 (0) 191 565 5348 Fax: +44 (0) 191 564 0002
 Website: www.tigerfiltration.com Email: sales@tigerfiltration.co.uk

Tiger Filtration Ltd

DVP

Alternative air/oil separator elements manufactured by **Tiger Filtration Ltd** to fit into **DVP** vacuum pumps

Alternative Filter Elements



Tiger P/No.	DVP P/No.	Pump Model	List Price £
DV1846	1801046	LB2/3/4/5/6	19.00
DV9033	9001033	LB8, LA12, LC12	28.00
DV9046	9001046	LB18/25, LV25, LA20	30.00
DV1873	1801073	LC25	34.00

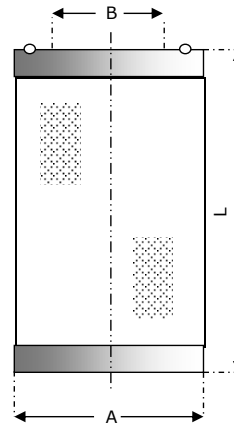

Tiger P/No.	A (mm)	B (mm)	L (mm)
DV1846	34	3/8" BSP	56
DV9033	45	20	62
DV9046	45	20	100
DV1873	45	20	150



Tiger Filtration Ltd

Unit 3, Rivergreen Industry Centre, Pallion, Sunderland, SR4 6AD, UK
 Tel: +44 (0) 191 565 5348 Fax: +44 (0) 191 564 0002
 Website: www.tigerfiltration.com Email: sales@tigerfiltration.co.uk

Tiger Filtration Ltd

Ecoair

Alternative filter elements manufactured by **Tiger Filtration Ltd** to fit into **Ecoair** filter housings

Alternative Filter Elements



Tiger P/No.	Ecoair P/No.	List Price £
EC01 (*)	E(*) 01	74.00
EC02 (*)	E(*) 02	87.00
EC03 (*)	E(*) 03	106.00
EC04 (*)	E(*) 04	141.00
EC05 (*)	E(*) 05	181.00
EC06 (*)	E(*) 06	225.00
EC07 (*)	E(*) 07	289.00
EC08 (*)	E(*) 08	342.00
EC09 (*)	E(*) 09	400.00
EC10 (*)	E(*) 10	663.00

(*) = grade - Example: EF 01 order as EC01 M1

M3 replaces V (3 Micron)

M1 replaces F (1 Micron)

MX replaces S (0.01 Micron & 0.01mg/m³ oil removal)

AC replaces A (Activated Carbon)



Tiger Filtration Ltd

Unit 3, Rivergreen Industry Centre, Pallion, Sunderland, SR4 6AD, UK

Tel: +44 (0) 191 565 5348 Fax: +44 (0) 191 564 0002

Website: www.tigerfiltration.com Email: sales@tigerfiltration.co.uk

Tiger Filtration Ltd

Edwards

Alternative air/oil separator elements manufactured by **Tiger Filtration Ltd** to fit into **Edwards** vacuum pumps

Alternative Filter Elements



Tiger P/No.	Edwards P/No.	List Price £
ED 057	A223 04 057	74.00
ED 020	A223 04 020	83.00
ED 021	A223 04 021	95.00

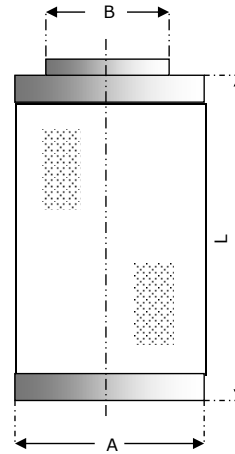

Tiger P/No.	A (mm)	B (mm)	L (mm)
ED057	80	31	173
ED020	80	31	252
ED021	80	55	380



Tiger Filtration Ltd

Unit 3, Rivergreen Industry Centre, Pallion, Sunderland, SR4 6AD, UK
 Tel: +44 (0) 191 565 5348 Fax: +44 (0) 191 564 0002
 Website: www.tigerfiltration.com Email: sales@tigerfiltration.co.uk

Tiger Filtration Ltd

Filterworld

Alternative filter elements manufactured by **Tiger Filtration Ltd** to fit into **Filterworld** filter housings

Alternative Filter Elements



Tiger P/No.	FW P/No.	List Price £
FW05 (*)	(*)C05	54.00
FW12 (*)	(*)C12	58.00
FW15 (*)	(*)C15	58.00
FW17 (*)	(*)C17	66.00
FW22 (*)	(*)C22	76.00
FW23 (*)	(*)C23	82.00
FW32 (*)	(*)C32	87.00
FW42 (*)	(*)C42	98.00
FW44 (*)	(*)C44	107.00
FW52 (*)	(*)C52	117.00
FW62 (*)	(*)C62	213.00
FW64 (*)	(*)C64	236.00
FW72 (*)	(*)C72	272.00
FW82 (*)	(*)C82	298.00
FW85 (*)	(*)C85	323.00

(*) = grade - Example: 01C12 order as FW12 M1
M25 replaces 25 (25 Micron)
M5 replaces 05 (5 Micron)
M1 replaces 01 (1 Micron)
MX replaces 00 (0.01 Micron & 0.01mg/m³ oil removal)
AC stays as AC (Activated Carbon)



Tiger Filtration Ltd

Unit 3, Rivergreen Industry Centre, Pallion, Sunderland, SR4 6AD, UK
Tel: +44 (0) 191 565 5348 Fax: +44 (0) 191 564 0002
Website: www.tigerfiltration.com Email: sales@tigerfiltration.co.uk

Tiger Filtration Ltd

Friulair - Current

Alternative filter elements manufactured by **Tiger Filtration Ltd** to fit into **Friulair** filter housings

Alternative Filter Elements



Tiger P/No.	Friulair P/No.	List Price £
FT008 (*)	T (*) 008	31.00
FT012 (*)	T (*) 012	36.00
FT018 (*)	T (*) 018	45.00
FT030 (*)	T (*) 030	58.00
FT055 (*)	T (*) 055	77.00
FT080 (*)	T (*) 080	93.00
FT120 (*)	T (*) 120	115.00
FT160 (*)	T (*) 160	166.00
FT220 (*)	T (*) 220	248.00
FT250 (*)	T (*) 250	198.00
FT400 (*)	T (*) 400	258.00

(*) = grade - Example: TS008 order as FT008 M1
 M5 replaces P (5 Micron)
 M1 replaces S (1 Micron)
 MX replaces X (0.01 Micron & 0.01mg/m³ oil removal)
 AC replaces Z (Activated Carbon)

N.B. The FT220 (*) element is for multi-candle fabricated vessels

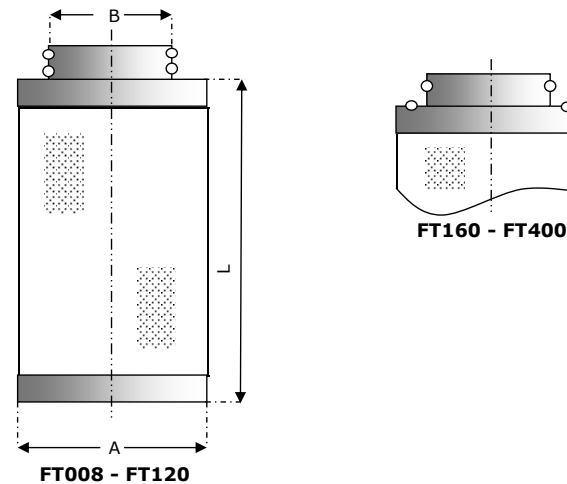

Tiger P/No.	A (mm)	B (mm)	L (mm)
FT008	51	23	61
FT012	51	23	72
FT018	51	23	140
FT030	75	45	119
FT055	75	45	219
FT080	75	45	319
FT120	75	45	497
FT160	91	71	509
FT220	91	71	680
FT250	91	71	766
FT400	140	102	751



Tiger Filtration Ltd

Unit 3, Rivergreen Industry Centre, Pallion, Sunderland, SR4 6AD, UK
 Tel: +44 (0) 191 565 5348 Fax: +44 (0) 191 564 0002
 Website: www.tigerfiltration.com Email: sales@tigerfiltration.co.uk

Tiger Filtration Ltd

Friulair - Previous

Alternative filter elements manufactured by **Tiger Filtration Ltd** to fit into **Friulair** filter housings

Alternative Filter Elements



Tiger P/No.	Friulair P/No.	List Price £
FL008 (*)	L (*) 008	31.00
FL011 (*)	L (*) 011	36.00
FL018 (*)	L (*) 018	45.00
FL031 (*)	L (*) 031	58.00
FL052 (*)	L (*) 052	77.00
FL075 (*)	L (*) 075	93.00
FL118 (*)	L (*) 118	115.00
FL168 (*)	L (*) 168	166.00
FL250 (*)	L (*) 250	198.00
FL400 (*)	L (*) 400	258.00

(*) = grade - Example: LS008 order as FL008 M1
 M5 replaces P (5 Micron)
 M1 replaces S (1 Micron)
 MX replaces X (0.01 Micron & 0.01mg/m³ oil removal)
 AC replaces Z (Activated Carbon)

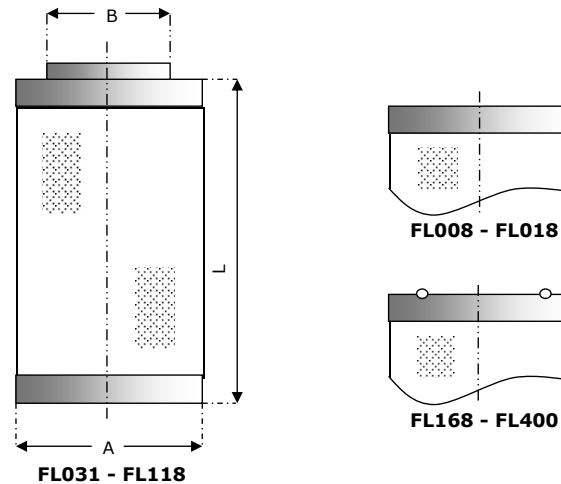

Tiger P/No.	A (mm)	B (mm)	L (mm)
FL008	51	24 (ID)	61
FL011	51	24 (ID)	72
FL018	51	24 (ID)	140
FL031	75	63	119
FL052	75	63	219
FL075	75	63	319
FL118	75	63	497
FL168	91	67 (ID)	509
FL250	91	67 (ID)	766
FL400	140	100 (ID)	751



Tiger Filtration Ltd

Unit 3, Rivergreen Industry Centre, Pallion, Sunderland, SR4 6AD, UK
 Tel: +44 (0) 191 565 5348 Fax: +44 (0) 191 564 0002
 Website: www.tigerfiltration.com Email: sales@tigerfiltration.co.uk

Tiger Filtration Ltd

FST

Alternative filter elements manufactured by **Tiger Filtration Ltd** to fit into **FST** filter housings

Alternative Filter Elements



Tiger P/No.	FST P/No.	List Price £
FST 25(*)	EFST 25(*)	60.00
FST 30(*)	EFST 30(*)	73.00
FST 50(*)	EFST 50(*)	82.00
FST 70(*)	EFST 70(*)	112.00
FST 90(*)	EFST 90(*)	142.00
FST 110(*)	EFST 110(*)	177.00
FST 120(*)	EFST 120(*)	206.00
FST 130(*)	EFST 130(*)	258.00
FST 140(*)	EFST 140(*)	310.00
FST 170(*)	EFST 170(*)	396.00
FST 180(*)	EFST 180(*)	542.00
FST 190(*)	EFST 190(*)	610.00

(*) = grade - Example: EFST 25V5 order as FST 25-M5
M5 replaces V5 (5 Micron)
M3 replaces V (3 Micron)
M1 replaces ZN (1 Micron)
MX replaces XN (0.01 Micron)
AC replaces A (Activated Carbon)



Tiger Filtration Ltd

Unit 3, Rivergreen Industry Centre, Pallion, Sunderland, SR4 6AD, UK
Tel: +44 (0) 191 565 5348 Fax: +44 (0) 191 564 0002
Website: www.tigerfiltration.com Email: sales@tigerfiltration.co.uk

Tiger Filtration Ltd

Gardner Denver

Alternative air/oil separator elements manufactured by **Tiger Filtration Ltd** to fit into **Gardner Denver** air compressors

Alternative Filter Elements



Tiger P/No.	GD P/No.	Nett Price £
GD03267728	3267728	POA
GD03340028	3340028	POA
GD60455401	60455401	POA
GD60455801	60455801	POA
GD89848519	89848519	POA



Tiger Filtration Ltd

Unit 3, Rivergreen Industry Centre, Pallion, Sunderland, SR4 6AD, UK
Tel: +44 (0) 191 565 5348 Fax: +44 (0) 191 564 0002
Website: www.tigerfiltration.com Email: sales@tigerfiltration.co.uk

Tiger Filtration Ltd

Gardner Denver

Alternative filter elements manufactured by **Tiger Filtration Ltd** to fit into **Gardner Denver** filter housings

Alternative Filter Elements



Tiger P/No.	GD P/No.	List Price £
GD12 (*)	FIL12 (*)	58.00
GD14 (*)	FIL14 (*)	64.00
GD16 (*)	FIL16 (*)	72.00
GD18 (*)	FIL18 (*)	107.00
GD20 (*)	FIL20 (*)	128.00
GD22 (*)	FIL22 (*)	160.00
GD24 (*)	FIL24 (*)	170.00
GD26 (*)	FIL26 (*)	258.00
GD28 (*)	FIL28 (*)	288.00
GD30 (*)	FIL30 (*)	325.00
GD32 (*)	FIL32 (*)	288.00
GD34 (*)	FIL34 (*)	345.00

(*) = grade - Example: FIL12CE order as GD12-M1
M25 replaces AE (25 Micron)
M3 replaces BE (3 Micron)
M1 replaces CE (1 Micron)
M0 replaces EE (0.1 Micron)
MX replaces FE (0.01 Micron)
RM1 replaces DE (1 Micron Dust Removal)
AC replaces GE (Activated Carbon)



Tiger Filtration Ltd

Unit 3, Rivergreen Industry Centre, Pallion, Sunderland, SR4 6AD, UK
Tel: +44 (0) 191 565 5348 Fax: +44 (0) 191 564 0002
Website: www.tigerfiltration.com Email: sales@tigerfiltration.co.uk

Tiger Filtration Ltd

Hankison NGF - Current

Alternative filter elements by **Tiger Filtration Ltd** to fit into **Hankison NGF** filter housings

Alternative Filter Elements



Tiger P/No.	Hankison P/No.	NETT Price £
HK02NGF (*)	02 (*)	40.00
HK03NGF (*)	03 (*)	42.00
HK04NGF (*)	04 (*)	47.00
HK06NGF (*)	06 (*)	56.00
HK07NGF (*)	07 (*)	66.00
HK08NGF (*)	08 (*)	73.00
HK10NGF (*)	10 (*)	82.00
HK11NGF (*)	11 (*)	103.00
HK12NGF (*)	12 (*)	119.00
HK13NGF (*)	13 (*)	160.00
HK14NGF (*)	14 (*)	174.00
HK15NGF (*)	15 (*)	186.00
HK16NGF (*)	16 (*)	214.00
HK17NGF (*)	17 (*)	241.00

(*) = grade - Example: 02-SF order as HK02NGF-M3
M3 replaces SF (3 Micron)
M1 replaces PF (1 Micron)
M0 replaces UF (0.1 Micron)
MX replaces HF (0.01 Micron & 0.01mg/m³ oil removal)
AC replaces CF (Activated Carbon)



Tiger Filtration Ltd

Unit 3, Rivergreen Industry Centre, Pallion, Sunderland, SR4 6AD, UK
Tel: +44 (0) 191 565 5348 Fax: +44 (0) 191 564 0002
Website: www.tigerfiltration.com Email: sales@tigerfiltration.co.uk

Tiger Filtration Ltd

Hankison - Previous

Alternative filter elements manufactured by **Tiger Filtration Ltd** to fit into **Hankison** filter housings

Alternative Filter Elements



Tiger P/No.	Hankison P/No.	List Price £
HK12 (*)	E (*) -12	47.00
HK16 (*)	E (*) - 16	64.00
HK20 (*)	E (*) - 20	83.00
HK24 (*)	E (*) - 24	105.00
HK28 (*)	E (*) - 28	131.00
HK32 (*)	E (*) - 32	146.00
HK36 (*)	E (*) - 36	183.00
HK40 (*)	E (*) - 40	218.00
HK44 (*)	E (*) - 44	245.00
HKPV (*)	E (*) - 52PV	262.00
HK48 (*)	E (*) - 48	253.00
HK54 (*)	E (*) - 54	253.00

(*) = grade - Example: E7-12 order as HK12 M1

M5 replaces 9 (5 Micron)

M1 replaces 7 (1 Micron)

RM1 replaces 6 (1 Micron Dust filter)

MX replaces 5 (0.01 Micron & 0.01mg/m³ oil removal)

MXX replaces 3 (0.01 Micron & 0.001mg/m³ oil removal)

AC replaces 1 (Activated Carbon)

N.B. The HK52PV (*) is for multi-candle fabricated vessels



Tiger Filtration Ltd

Unit 3, Rivergreen Industry Centre, Pallion, Sunderland, SR4 6AD, UK

Tel: +44 (0) 191 565 5348 Fax: +44 (0) 191 564 0002

Website: www.tigerfiltration.com Email: sales@tigerfiltration.co.uk

Tiger Filtration Ltd

Hi-Line

Alternative filter elements manufactured by **Tiger Filtration Ltd** to fit into **Hi-Line** filter housings

Alternative Filter Elements



Tiger P/No.	Hi-Line P/No.	List Price £
HL25 (*)	HE25-(*)	50.00
HL36 (*)	HE36-(*)	62.00
HL50 (*)	HE50-(*)	70.00
HL72 (*)	HE72-(*)	90.00
HL120 (*)	HE120-(*)	116.00
HL210 (*)	HE210-(*)	151.00
HL320 (*)	HE320-(*)	194.00
HL500 (*)	HE500-(*)	242.00
HL630 (*)	HE630-(*)	320.00
HL850 (*)	HE850-(*)	378.00
HL1400 (*)	HE1400-(*)	535.00
HL1700 (*)	HE1700-(*)	700.00

(*) = grade - Example: HE25-3 order as HL25 M1
 M3 replaces 2 (3 Micron)
 M1 replaces 3 (1 Micron)
 MX replaces 4 (0.01 Micron & 0.01mg/m³ oil removal)
 AC replaces 5 (Activated Carbon)

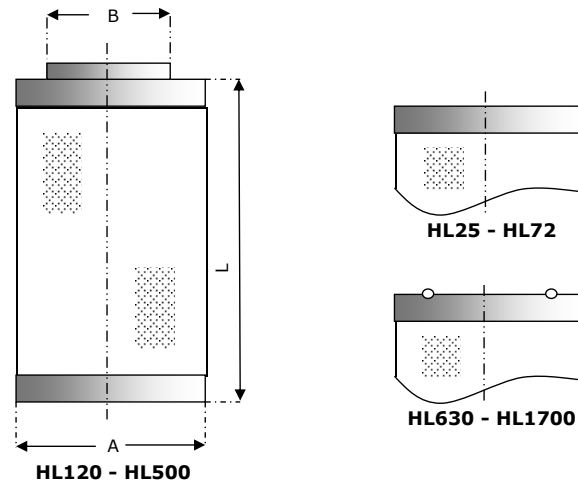

Tiger P/No.	A (mm)	B (mm)	L (mm)
HL25-(*)	51	24(ID)	51
HL36-(*)	51	24(ID)	61
HL50-(*)	51	24(ID)	72
HL72-(*)	51	24(ID)	140
HL120-(*)	75	63	110
HL210-(*)	75	63	210
HL320-(*)	75	63	310
HL500-(*)	75	63	500
HL630-(*)	91	67 (ID)	509
HL850-(*)	91	67 (ID)	766
HL1400-(*)	140	100 (ID)	616
HL1700-(*)	140	100 (ID)	751



Tiger Filtration Ltd

Unit 3, Rivergreen Industry Centre, Pallion, Sunderland, SR4 6AD, UK
 Tel: +44 (0) 191 565 5348 Fax: +44 (0) 191 564 0002
 Website: www.tigerfiltration.com Email: sales@tigerfiltration.co.uk

Tiger Filtration Ltd

Hiross (Parker)

Alternative filter elements manufactured by **Tiger Filtration Ltd** to fit into **Hiross (Parker)** filter housings

Alternative Filter Elements



Tiger P/No.	Hiross P/No.	List Price £
HR005 (*)	005 (*)	45.00
HR010 (*)	002 (*) - 004 (*) - 006 (*) - 010 (*)	45.00
HR016 (*)	007 (*) - 009 (*) - 016 (*)	58.00
HR022 (*)	014 (*) - 015 (*) - 018 (*) - 020 (*) - 022 (*)	65.00
HR030 (*)	024 (*) - 030 (*)	68.00
HR045 (*)	035 (*) - 045 (*)	75.00
HR072 (*)	060 (*) - 062 (*) - 072 (*)	96.00
HR135 (*)	090 (*) - 110 (*) - 122 (*) - 135 (*)	132.00
HR175 (*)	175 (*)	148.00
HR205 (*)	120 (*) - 151 (*) - 205 (*)	169.00
HR180 (*)	150 (*) - 180 (*)	182.00
HR250 (*)	250 (*)	182.00
HR260 (*)	260 (*)	260.00
HR280 (*)	240 (*) - 280 (*)	276.00
HR300 (*)	300 (*)	234.00
HR370 (*)	370 (*)	324.00

(*) = grade - Example: 005P order as HR005 M1
 M5 replaces Q (5 Micron)
 M1 replaces P (1 Micron)
 MX replaces S (0.01 Micron)
 AC replaces C (Activated Carbon)

N.B. The HR250 element is for fabricated housing with multiple elements and will be supplied with a 13.5mm dia through hole.



Tiger Filtration Ltd

Unit 3, Rivergreen Industry Centre, Pallion, Sunderland, SR4 6AD, UK
 Tel: +44 (0) 191 565 5348 Fax: +44 (0) 191 564 0002
 Website: www.tigerfiltration.com Email: sales@tigerfiltration.co.uk

Tiger Filtration Ltd

HPC Evolution - Current

Alternative filter elements by **Tiger Filtration Ltd** to fit into **HPC** Evolution filter housings

Alternative Filter Elements



Tiger P/No.	HPC P/No.	List Price £
HP010 (*)-N	010 (*)	46.00
HP015 (*)-N	015 (*)	73.00
HP020 (*)-N	020 (*)	85.00
HP025 (*)-N	025 (*)	103.00
HP030 (*)-N	030 (*)	121.00
HP035 (*)-N	035 (*)	138.00
HP040 (*)-N	040 (*)	163.00
HP045 (*)-N	045 (*)	233.00
HP050 (*)-N	050 (*)	275.00
HP055 (*)-N	055 (*)	369.00
HP100 (*)-N	100 (*)	162.00

Multi-Element

HP060 (*)-N	060 (*)	233.00
-------------	---------	--------

Tiger P/No.	HPC P/No.	NETT Price £
HP150 (*)-N	150 (*)	115.00
HP200 (*)-N	200 (*)	157.00

(*) = grade - Example: 010AO order as HP010 M1-N
M1 replaces AO (1 Micron)
MX replaces AA (0.01 Micron)
AC replaces ACS (Activated Carbon)



Tiger Filtration Ltd

Unit 3, Rivergreen Industry Centre, Pallion, Sunderland, SR4 6AD, UK
Tel: +44 (0) 191 565 5348 Fax: +44 (0) 191 564 0002
Website: www.tigerfiltration.com Email: sales@tigerfiltration.co.uk

Tiger Filtration Ltd

HPC - Previous

Alternative filter elements manufactured by **Tiger Filtration Ltd** to fit into **HPC** filter housings

Tiger P/No.	HPC P/No.	List Price £
HP009 (*)	K009 (*)	40.00
HP017 (*)	K017 (*)	67.00
HP030 (*)	K030 (*)	78.00
HP058 (*)	K058 (*)	97.00
HP145 (*)	K145 (*)	127.00
HP220 (*)	K220 (*)	151.00
HP330 (*)	K330 (*)	218.00
HP430 (*)	K430 (*)	258.00
HP620 (*)	K620 (*)	349.00

(*) = grade - Example: K009 AO order as HP009 M1
 M1 replaces AO (1 Micron)
 MX replaces AA (0.01 Micron & 0.01mg/m³ oil removal)

Tiger P/No.	HPC P/No.	List Price £
HP006 (*)	K006 (*)	40.00
HP013 (*)	K013 (*)	67.00
HP025 (*)	K025 (*)	78.00
HP040 (*)	K040 (*)	97.00
HP085 (*)	K085 (*)	127.00
HP195 (*)	K195 (*)	151.00
HP295 (*)	K295 (*)	218.00
HP400 (*)	K400 (*)	258.00
HP500 (*)	K500 (*)	349.00

(*) = grade - Example: K006 AO order as HP006 M1
 M1 replaces AO (1 Micron)
 MX replaces AA (0.01 Micron & 0.01mg/m³ oil removal)

Alternative Filter Elements



Grade AC		Activated Carbon	
Tiger P/No.	HPC P/No.	Tiger P/No.	HPC P/No.
HP006 ACC	K006 AC	HP006 ACC	K006 AC
HP013 ACC	K013 AC	HP013 ACC	K013 AC
HP025 ACC	K025 AC	HP025 ACC	K025 AC
HP040 ACC	K040 AC	HP040 ACC	K040 AC
HP065 ACC	K065 AC	HP065 ACC	K065 AC
HP085 ACC	K085 AC	HP085 ACC	K085 AC
HP195 AC	K195 AC	HP195 AC	K195 AC
HP295 AC	K295 AC	HP295 AC	K295 AC
HP400 AC	K400 AC	HP400 AC	K400 AC
HP500 AC	K500 AC	HP500 AC	K500 AC

ACC = AC Element For Duplex Housing



Tiger Filtration Ltd

Unit 3, Rivergreen Industry Centre, Pallion, Sunderland, SR4 6AD, UK
 Tel: +44 (0) 191 565 5348 Fax: +44 (0) 191 564 0002
 Website: www.tigerfiltration.com Email: sales@tigerfiltration.co.uk

Tiger Filtration Ltd

Hydrovane

Alternative filter elements manufactured by **Tiger Filtration Ltd** to fit into **Hydrovane** filter housings

Alternative Filter Elements



Tiger P/No.	Hydro P/No.	List Price £
HY100 (*)	(*) 100 E	40.00
HY150 (*)	(*) 150 E	67.00
HY200 (*)	(*) 200 E	78.00
HY250 (*)	(*) 250 E	97.00
HY350 (*)	(*) 350 E	127.00
HY450 (*)	(*) 450 E	151.00
HY500 (*)	(*) 500 E	218.00
HY530 (*)	(*) 530 E	258.00
HY600 (*)	(*) 600 E	349.00

(*) = grade - Example: GP100 E order as HY100 M1
 M1 replaces GP & DR (1 Micron)
 MX replaces HE (0.01 Micron & 0.01mg/m³ oil removal)

Grade AC	Activated Carbon	
Tiger P/No.	Hydro P/No.	List Price £
HY100 ACC	OR100 E	34.00
HY150 ACC	OR150 E	37.00
HY200 ACC	OR200 E	50.00
HY250 ACC	OR250 E	70.00
HY300 ACC	OR300 E	123.00
HY350 ACC	OR350 E	155.00
HY450 AC	OR450 E	151.00
HY500 AC	OR500 E	218.00
HY530 AC	OR530 E	258.00
HY600 AC	OR600 E	349.00

ACC = Activated Carbon Element For Duplex Housing



Tiger Filtration Ltd

Unit 3, Rivergreen Industry Centre, Pallion, Sunderland, SR4 6AD, UK
 Tel: +44 (0) 191 565 5348 Fax: +44 (0) 191 564 0002
 Website: www.tigerfiltration.com Email: sales@tigerfiltration.co.uk

Tiger Filtration Ltd

Hydrovane

Alternative air/oil separator elements manufactured by **Tiger Filtration Ltd** to fit into **Hydrovane** air compressors

Alternative Filter Elements



Tiger P/No.	Hydro P/No.	List Price £
HY52022	52022	33.00
HY3415	3415	33.00
HY3407	3407	33.00
HY52471	52471	33.00
HY57029	57029	33.00
HY59177	59177	35.00
HY70166	70166	23.00
HY70539	70539	35.00
HY59180	59180	35.00

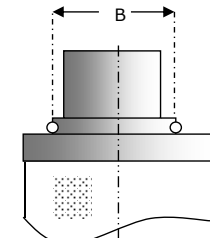
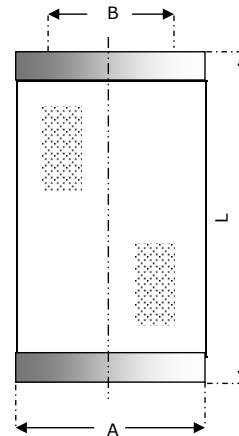

HY70539 & HY59180

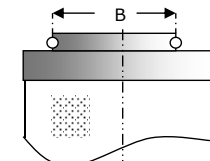

HY57029 & HY59177

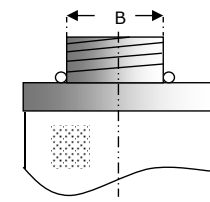

HY70166

Tiger P/No.	A (mm)	B (mm)	L (mm)
HY52022	70	40 (ID)	70
HY3415	70	40 (ID)	200
HY3407	70	40 (ID)	255
HY52471	70	40 (ID)	175
HY57029	70	40	84
HY59177	70	40	204
HY70166	21.5	1/8" BSP	31
HY70539	70	40	204
HY59180	70	40	255



Tiger Filtration Ltd

Unit 3, Rivergreen Industry Centre, Pallion, Sunderland, SR4 6AD, UK
 Tel: +44 (0) 191 565 5348 Fax: +44 (0) 191 564 0002
 Website: www.tigerfiltration.com Email: sales@tigerfiltration.co.uk

Tiger Filtration Ltd

Ingersoll Rand - Gooseneck Style (2003 - 2011) - Current

Alternative filter elements by **Tiger Filtration Ltd** to fit into **Ingersoll Rand** filter housings

Alternative Filter Elements



Tiger P/No.	Ingersoll Rand P/No.	NETT Price £
IR19 (*)	GP/HE/AC/DP 19	35.00
IR40 (*)	GP/HE/AC/DP 40	37.00
IR64 (*)	GP/HE/AC/DP 64	45.00
IR123 (*)	GP/HE/AC/DP 123	56.00
IR216 (*)	GP/HE/AC/DP 216	59.00
IR275 (*)	GP/HE/AC/DP 275	66.00
IR350 (*)	GP/HE/AC/DP 350	87.00
IR481 (*)	GP/HE/AC/DP 481	99.00
IR563 (*)	GP/HE/AC/DP 563	107.00
IR706 (*)	GP/HE/AC/DP 706	130.00
IR850 (*)	GP/HE/AC/DP 850	183.00
IR1100 (*)	GP/HE/AC/DP 1100	214.00
IR1380 (*)	GP/HE/AC/DP 1380	227.00
IR424 (*)	GP/HE/AC/DP 424	52.00
IR699 (*)	GP/HE/AC/DP 699	73.00
IR1314 (*)	GP/HE/AC/DP 1314	140.00

(*) = grade - Example: GP 19 order as IR19-M1

M1 replaces GP (1 Micron)

MX replaces HE (0.01 Micron & 0.01mg/m³ oil removal)

RM1 replaces DP (1 Micron Dust)

AC replaces AC (Activated Carbon)



Tiger Filtration Ltd

Unit 3, Rivergreen Industry Centre, Pallion, Sunderland, SR4 6AD, UK

Tel: +44 (0) 191 565 5348 Fax: +44 (0) 191 564 0002

Website: www.tigerfiltration.com Email: sales@tigerfiltration.co.uk

Tiger Filtration Ltd

Ingersoll Rand - Previous

Alternative filter elements manufactured by **Tiger Filtration Ltd** to fit into **Ingersoll Rand** filter housings

Alternative Filter Elements



			Grade AC	Activated Carbon		
Tiger P/No.	IR P/No.	List Price £	Tiger P/No.	IR P/No.	List Price £	
IR5 (*)	5 (*)	40.00	IR5 AC	5 ACS	40.00	
IR10 (*)	10 (*)	67.00	IR10 AC	10 ACS	67.00	
IR18 (*)	18 (*)	78.00	IR18 AC	18 ACS	78.00	
IR36 (*)	36 (*)	97.00	IR36 AC	36 ACS	97.00	
IR48 (*)	48 (*)	127.00	IR48 AC	48 ACS	127.00	
IR119 (*)	119 (*)	151.00	IR119 AC	119 ACS	151.00	
IR198 (*)	198 (*)	218.00	IR198 AC	198 ACS	218.00	
IR239 (*)	239 (*)	258.00	IR239 AC	239 ACS	258.00	
IR372 (*)	372 (*)	349.00	IR372 AC	372 ACS	349.00	

(*) = grade - Example: 5 AO order as IR5 M1
 M1 replaces AO & AR (1 Micron)
 MX replaces AA (0.01 Micron & 0.01mg/m³ oil removal)

			Grade AC	Activated Carbon		
Tiger P/No.	IR P/No.	List Price £	Tiger P/No.	IR P/No.	List Price £	
IR4 (*)	E4 (*)	40.00	IR4 ACC	E4 AC	34.00	
IR8 (*)	E8 (*)	67.00	IR8 ACC	E8 AC	35.00	
IR15 (*)	E15 (*)	78.00	IR15 ACC	E15 AC	50.00	
IR24 (*)	E24 (*)	97.00	IR24 ACC	E24 AC	70.00	
IR50 (*)	E50 (*)	127.00	IR39 ACC	E39 AC	123.00	
IR125 (*)	E125 (*)	151.00	IR50 ACC	E50 AC	155.00	
IR180 (*)	E180 (*)	218.00	IR125 AC	E125 AC	151.00	
IR240 (*)	E240 (*)	258.00	IR180 AC	E180 AC	218.00	
IR300 (*)	E300 (*)	349.00	IR240 AC	E240 AC	258.00	
			IR300 AC	E300 AC	349.00	

(*) = grade - Example: E4 AO order as IR4 M1
 M1 replaces AO & AR (1 Micron)
 MX replaces AA (0.01 Micron & 0.01mg/m³ oil removal)



Tiger Filtration Ltd

Unit 3, Rivergreen Industry Centre, Pallion, Sunderland, SR4 6AD, UK
 Tel: +44 (0) 191 565 5348 Fax: +44 (0) 191 564 0002
 Website: www.tigerfiltration.com Email: sales@tigerfiltration.co.uk

Tiger Filtration Ltd

Kaeser

Alternative filter elements manufactured by **Tiger Filtration Ltd** to fit into **Kaeser** filter housings

Alternative Filter Elements



Tiger P/No.	Kaeser P/No.	List Price £
KA006 (*)	E - (*) - 6	47.00
KA010 (*)	E - (*) - 10	64.00
KA018 (*)	E - (*) - 18	83.00
KA028 (*)	E - (*) - 28	105.00
KA048 (*)	E - (*) - 48	131.00
KA071 (*)	E - (*) - 71	146.00
KA107 (*)	E - (*) - 107	183.00
KA138 (*)	E - (*) - 138	215.00
KA177 (*)	E - (*) - 177	245.00
KA185 (*)	E - (*) - 185	262.00
KA221 (*)	E - (*) - 221	253.00
KA283 (*)	E - (*) - 283	253.00

(*) = grade - Example: E-C-6 order as KS006 M1

M5 replaces B (5 Micron)

M1 replaces C (1 Micron)

MX replaces E (0.01 Micron & 0.01mg/m³ oil removal)

MXX replaces F (0.01 Micron & 0.001mg/m³ oil removal)

AC replaces G (Activated Carbon)

RM1 replaces D (1 micron)



Tiger Filtration Ltd

Unit 3, Rivergreen Industry Centre, Pallion, Sunderland, SR4 6AD, UK

Tel: +44 (0) 191 565 5348 Fax: +44 (0) 191 564 0002

Website: www.tigerfiltration.com Email: sales@tigerfiltration.co.uk

Tiger Filtration Ltd

Alternative Filter Elements

Leybold

Alternative air/oil separator elements manufactured by **Tiger Filtration Ltd** to fit into **Leybold** vacuum pumps



Tiger P/No.	Leybold P/No.	Pump Model	List Price £
LY023	712-32-023	SV16 - 25	61.00
LY763	710-64-763	SV40 - 200	72.00
LY773	710-64-773	SV280 - 1200	83.00
LY180	714-21-180	SV40B	45.00
LY300	714-17-300	SV65B - 100B	49.00
LY120	714-31-120	SV200B,300B,630B,750B	59.00
LY971	18971	D4A-B-AC,D8B,D2A-AC	46.00
LY973	18973	D40B-BCS, D65B-BCS	54.00
LY975	18975	D8A, D16A	46.00

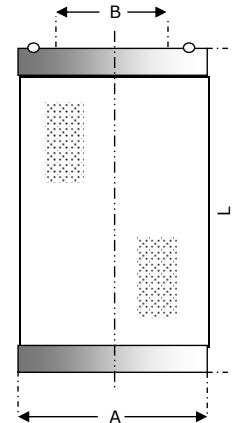

Tiger P/No.	A (mm)	B (mm)	L (mm)
LY023	55	24 (ID)	152
LY763	66	40 (ID)	228
LY773	66	40 (ID)	400
LY180	73	47.5 (ID)	188
LY300	73	47.5 (ID)	225
LY120	73	47.5 (ID)	401
LY971	54	25 (ID)	75
LY973	54	25 (ID)	175
LY975	54	25 (ID)	95



Tiger Filtration Ltd

Unit 3, Rivergreen Industry Centre, Pallion, Sunderland, SR4 6AD, UK
 Tel: +44 (0) 191 565 5348 Fax: +44 (0) 191 564 0002
 Website: www.tigerfiltration.com Email: sales@tigerfiltration.co.uk

Tiger Filtration Ltd

Mark

Alternative filter elements manufactured by **Tiger Filtration Ltd** to fit into **Mark** filter housings

Alternative Filter Elements



Tiger P/No.	Mark P/No.	List Price £
MK10 (*)	10 (*)	37.00
MK13 (*)	13 (*)	46.00
MK20 (*)	20 (*)	58.00
MK33 (*)	33 (*)	72.00
MK60 (*)	60 (*)	98.00
MK85 (*)	85 (*)	117.00
MK130 (*)	130 (*)	148.00
MK170 (*)	170 (*)	182.00
MK250 (*)	250 (*)	208.00
MK400 (*)	400 (*)	299.00

(*) = grade - Example: 10FPRE order as MK10 M1

M3 replaces FPRO (3 Micron)

M1 replaces FPRE (1 Micron)

M0 replaces FMO (0.1 Micron)

MX replaces FMM (0.01 Micron)

AC replaces FCA (Activated Carbon)



Tiger Filtration Ltd

Unit 3, Rivergreen Industry Centre, Pallion, Sunderland, SR4 6AD, UK

Tel: +44 (0) 191 565 5348 Fax: +44 (0) 191 564 0002

Website: www.tigerfiltration.com Email: sales@tigerfiltration.co.uk

Tiger Filtration Ltd

Mattei

Alternative filter elements manufactured by **Tiger Filtration Ltd** to fit into **Mattei** filter housings

Alternative Filter Elements



Tiger P/No.	Mattei P/No.	List Price £
MA005 (*)	04E 0030 (*)	27.00
MA010 (*)	04E 0060 (*)	31.00
MA018 (*)	04E 0108 (*)	40.00
MA030 (*)	04E 0180 (*)	43.00
MA034 (*)	04E 0204 (*)	46.00
MA050 (*)	04E 0300 (*)	56.00
MA072 (*)	04E 0432 (*)	62.00
MA095 (*)	04E 0570 (*)	81.00
MA125 (*)	04E 0750 (*)	106.00
MA165 (*)	04E 0990 (*)	130.00
MA190 (*)	04E 1140 (*)	139.00
MA220 (*)	04E 1320 (*)	181.00

(*) = grade - Example: 04E 0030 PF order as MA005 M1

M25 replaces D (25 Micron)

M5 replaces Q (5 Micron)

M1 replaces P (1 Micron)

MX replaces H (0.01 Micron & 0.01mg/m³ oil removal)

MXX replaces S (0.01 Micron & 0.001mg/m³ oil removal)

AC replaces C (Activated Carbon)



Tiger Filtration Ltd

Unit 3, Rivergreen Industry Centre, Pallion, Sunderland, SR4 6AD, UK

Tel: +44 (0) 191 565 5348 Fax: +44 (0) 191 564 0002

Website: www.tigerfiltration.com Email: sales@tigerfiltration.co.uk

Tiger Filtration Ltd

Mattei

Alternative air/oil separator elements manufactured by **Tiger Filtration Ltd** to fit into **Mattei** air compressors

Grade M1/RM1 1 Micron

Tiger P/No.	Mattei P/No.	List Price £
MA20113	CR2201130	39.00
MA30725	CR21F30725	35.00
MA30732	CR21A30732	33.00
MA30733	CR21H30733	43.00

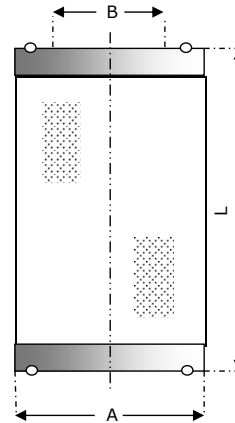

Tiger P/No.	A (mm)	B (mm)	L (mm)
MA20113	100	70 (ID)	252
MA30725	70	40 (ID)	200
MA30732	70	40 (ID)	255
MA30733	70	40 (ID)	400

Alternative Filter Elements



Tiger Filtration Ltd

Unit 3, Rivergreen Industry Centre, Pallion, Sunderland, SR4 6AD, UK
 Tel: +44 (0) 191 565 5348 Fax: +44 (0) 191 564 0002
 Website: www.tigerfiltration.com Email: sales@tigerfiltration.co.uk

Tiger Filtration Ltd

MIKROPOR

Alternative filter elements manufactured by **Tiger Filtration Ltd** to fit into **MIKROPOR** filter housings

Alternative Filter Elements



Tiger P/No.	Mikropor P/No.	List Price £
MP24 (*)	M24 (*)	20.00
MP48 (*)	M48 (*)	20.00
MP25 (*)	M25 (*)	30.00
MP50 (*)	M50 (*)	30.00
MP100 (*)	M100 (*)	35.00
MP150 (*)	M150 (*)	47.00
MP200 (*)	M200 (*)	55.00
MP250 (*)	M250 (*)	61.00
MP300 (*)	M300 (*)	81.00
MP500 (*)	M500 (*)	73.00
MP600 (*)	M600 (*)	77.00
MP851 (*)	M851 (*)	158.00
MP1210 (*)	M1210 (*)	166.00
MP1510 (*)	M1510 (*)	291.00
MP1810 (*)	M1810 (*)	327.00
MP2210 (*)	M2210 (*)	374.00

(*) = grade - Example: M24 X order as MP24 M1
M5 replaces P (5 Micron)
M1 replaces X (1 Micron)
MX replaces Y (0.01 Micron & 0.01mg/m³ oil removal)
AC replaces A (Activated Carbon)



Tiger Filtration Ltd

Unit 3, Rivergreen Industry Centre, Pallion, Sunderland, SR4 6AD, UK
Tel: +44 (0) 191 565 5348 Fax: +44 (0) 191 564 0002
Website: www.tigerfiltration.com Email: sales@tigerfiltration.co.uk

Tiger Filtration Ltd

M.T.A.

Alternative filter elements manufactured by **Tiger Filtration Ltd** to fit into **M.T.A.** filter housings

Alternative Filter Elements



Tiger P/No.	MTA P/No.	List Price £
MT6050 (*)	6050 (*)	22.00
MT7050 (*)	7050 (*)	27.00
MT14050 (*)	14050 (*)	36.00
MT12075 (*)	12075 (*)	46.00
MT22075 (*)	22075 (*)	59.00
MT32075 (*)	32075 (*)	72.00
MT50075 (*)	50075 (*)	93.00
MT51090 (*)	51090 (*)	128.00
MT75140 (*)	75140 (*)	155.00
MT76090 (*)	76090 (*)	232.00

(*) = grade - Example: 6050M order as MT6050 M1
 M3 replaces P (3 Micron)
 M1 replaces M (1 Micron)
 MX replaces S (0.01 Micron & 0.01mg/m³ oil removal)
 AC replaces A (Activated Carbon)

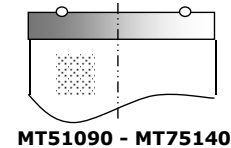
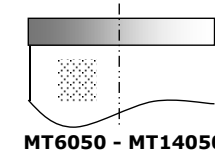
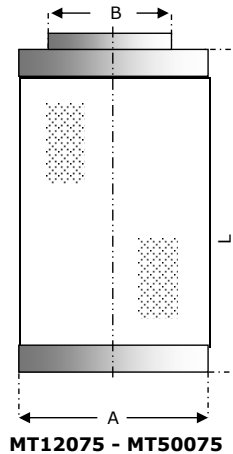

Tiger P/No.	A (mm)	B (mm)	L (mm)
MT6050	51	24 (ID)	61
MT7050	51	24 (ID)	72
MT14050	51	24 (ID)	140
MT12075	75	63	119
MT22075	75	63	219
MT32075	75	63	319
MT50075	75	63	500
MT51090	91	67 (ID)	509
MT75140	91	67 (ID)	766
MT76090	140	100 (ID)	751



Tiger Filtration Ltd

Unit 3, Rivergreen Industry Centre, Pallion, Sunderland, SR4 6AD, UK
 Tel: +44 (0) 191 565 5348 Fax: +44 (0) 191 564 0002
 Website: www.tigerfiltration.com Email: sales@tigerfiltration.co.uk

Tiger Filtration Ltd

Omega

Alternative filter elements manufactured by **Tiger Filtration Ltd** to fit into **Omega** filter housings

Alternative Filter Elements



Tiger P/No.	Omega P/No.	List Price £
OM6050 (*)	06050 (*)	37.00
OM7050 (*)	07050 (*)	46.00
OM14050 (*)	14050 (*)	58.00
OM12075 (*)	12075 (*)	72.00
OM22075 (*)	22075 (*)	98.00
OM32075 (*)	32075 (*)	117.00
OM50075 (*)	50075 (*)	148.00
OM51090 (*)	51090 (*)	182.00
OM76090 (*)	76090 (*)	208.00
OM51140 (*)	51140 (*)	262.00
OM75140 (*)	75140 (*)	299.00

(*) = grade - Example: 06050 R order as OM6050 M1

M3 replaces P (3 Micron)

M1 replaces R (1 Micron)

M0 replaces M (0.1 Micron)

MX replaces S (0.01 Micron & 0.01mg/m³ oil removal)

AC replaces A (Activated Carbon)



Tiger Filtration Ltd

Unit 3, Rivergreen Industry Centre, Pallion, Sunderland, SR4 6AD, UK

Tel: +44 (0) 191 565 5348 Fax: +44 (0) 191 564 0002

Website: www.tigerfiltration.com Email: sales@tigerfiltration.co.uk

Tiger Filtration Ltd

OMI - Current

Alternative filter elements manufactured by **Tiger Filtration Ltd** to fit into **OMI** filter housings

Alternative Filter Elements



Tiger P/No.	OMI P/No.	List Price £
OM005 (*)	04E 0030 (*)	27.00
OM010 (*)	04E 0060 (*)	31.00
OM018 (*)	04E 0108 (*)	40.00
OM030 (*)	04E 0180 (*)	43.00
OM034 (*)	04E 0204 (*)	46.00
OM050 (*)	04E 0300 (*)	56.00
OM072 (*)	04E 0432 (*)	62.00
OM095 (*)	04E 0570 (*)	81.00
OM125 (*)	04E 0750 (*)	106.00
OM165 (*)	04E 0990 (*)	130.00
OM190 (*)	04E 1140 (*)	139.00
OM220 (*)	04E 1320 (*)	181.00

(*) = grade - Example: 04E 0030 PF order as OM005 M1
M10 replaces DF (10 Micron)
M5 replaces QF (5 Micron)
M1 replaces PF (1 Micron)
MX replaces HF (0.01 Micron & 0.01mg/m³ oil removal)
AC replaces CF (Activated Carbon)



Tiger Filtration Ltd

Unit 3, Rivergreen Industry Centre, Pallion, Sunderland, SR4 6AD, UK
Tel: +44 (0) 191 565 5348 Fax: +44 (0) 191 564 0002
Website: www.tigerfiltration.com Email: sales@tigerfiltration.co.uk

Tiger Filtration Ltd

OMI - Previous

Alternative filter elements manufactured by **Tiger Filtration Ltd** to fit into **OMI** filter housings

Alternative Filter Elements



Grade M5 (QF) 5 Micron

Tiger P/No.	OMI P/No.	List Price £
OM005 M5	040 F050	27.00
OM010 M5	040 F051	31.00
OM018 M5	040 F052	40.00
OM034 M5	040 F053	46.00
OM050 M5	040 F054	56.00
OM095 M5	040 F055	81.00
OM125 M5	040 F056	106.00
OM125 M5	040 F057	106.00
OM165 M5	040 F058	130.00
OM220 M5	040 F059	181.00

Grade M1 (PF) 1 Micron

Tiger P/No.	OMI P/No.	List Price £
OM005 M1	041 F150	27.00
OM010 M1	041 F151	31.00
OM018 M1	041 F152	40.00
OM034 M1	041 F153	46.00
OM050 M1	041 F154	56.00
OM095 M1	041 F155	81.00
OM125 M1	041 F156	106.00
OM125 M1	041 F157	106.00
OM165 M1	041 F158	130.00
OM220 M1	041 F159	181.00

Grade M0 (HF) 0.1 Micron

Tiger P/No.	OMI P/No.	List Price £
OM005 M0	042 F250	27.00
OM010 M0	042 F251	31.00
OM018 M0	042 F252	40.00
OM034 M0	042 F253	46.00
OM050 M0	042 F254	56.00
OM095 M0	042 F255	81.00
OM125 M0	042 F256	106.00
OM125 M0	042 F257	106.00
OM165 M0	042 F258	130.00
OM220 M0	042 F259	181.00

Grade AC (CF) Activated Carbon

Tiger P/No.	OMI P/No.	List Price £
OM005 AC	043 F350	27.00
OM010 AC	043 F351	31.00
OM018 AC	043 F352	40.00
OM034 AC	043 F353	46.00
OM050 AC	043 F354	56.00
OM095 AC	043 F355	81.00
OM125 AC	043 F356	106.00
OM125 AC	043 F357	106.00
OM165 AC	043 F358	130.00
OM220 AC	043 F359	181.00



Tiger Filtration Ltd

Unit 3, Rivergreen Industry Centre, Pallion, Sunderland, SR4 6AD, UK
 Tel: +44 (0) 191 565 5348 Fax: +44 (0) 191 564 0002
 Website: www.tigerfiltration.com Email: sales@tigerfiltration.co.uk

Tiger Filtration Ltd

Pall/PPC

Alternative filter elements manufactured by **Tiger Filtration Ltd** to fit into **Pall/PPC** filter housings

Tiger P/No.	Pall P/No.	List Price £
P3A13 M3	PPFK3A13 AF	POA
P3A13 MX	PPFK3A13 SU	POA
P3A13 HT	PPFK3A13 HT	POA
P3A13 AC	PPFK3A13 A	POA

Tiger P/No.	Pall P/No.	List Price £
P2A10 M3	PPFK2A10 AF	POA
P2A10 MX	PPFK2A10 SU	POA
P2A10 HT	PPFK2A10 HT	POA
P2A10 AC	PPFK2A10 A	POA

Alternative Filter Elements



Tiger Filtration Ltd

Unit 3, Rivergreen Industry Centre, Pallion, Sunderland, SR4 6AD, UK
Tel: +44 (0) 191 565 5348 Fax: +44 (0) 191 564 0002
Website: www.tigerfiltration.com Email: sales@tigerfiltration.co.uk

Tiger Filtration Ltd

Pneumatech

Alternative filter elements manufactured by **Tiger Filtration Ltd** to fit into **Pneumatech** filter housings

Alternative Filter Elements



Grade M3 3 Micron

Tiger P/No.	Pn-tech P/No.	List Price £
PT01 M3	1624-5000-01	37.00
PT06 M3	1624-5000-06	46.00
PT11 M3	1624-5000-11	58.00
PT16 M3	1624-5000-16	72.00
PT21 M3	1624-5000-21	98.00
PT26 M3	1624-5000-26	117.00
PT31 M3	1624-5000-31	148.00
PT36 M3	1624-5000-36	182.00
PT41 M3	1624-5000-41	208.00
PT46 M3	1624-5000-46	262.00
PT51 M3	1624-5000-51	299.00

Grade M1 1 Micron

Tiger P/No.	Pn-tech P/No.	List Price £
PT05 M1	1624-5000-05	37.00
PT10 M1	1624-5000-10	46.00
PT15 M1	1624-5000-15	58.00
PT20 M1	1624-5000-20	72.00
PT25 M1	1624-5000-25	98.00
PT30 M1	1624-5000-30	117.00
PT35 M1	1624-5000-35	148.00
PT40 M1	1624-5000-40	182.00
PT45 M1	1624-5000-45	208.00
PT50 M1	1624-5000-50	262.00
PT55 M1	1624-5000-55	299.00

Grade M0 0.1 Micron

Tiger P/No.	Pn-tech P/No.	List Price £
PT04 M0	1624-5000-04	37.00
PT09 M0	1624-5000-09	46.00
PT14 M0	1624-5000-14	58.00
PT19 M0	1624-5000-19	72.00
PT24 M0	1624-5000-24	98.00
PT29 M0	1624-5000-29	117.00
PT34 M0	1624-5000-34	148.00
PT39 M0	1624-5000-39	182.00
PT44 M0	1624-5000-44	208.00
PT49 M0	1624-5000-49	262.00
PT54 M0	1624-5000-54	299.00

Grade MX 0.01 Micron

Tiger P/No.	Pn-tech P/No.	List Price £
PT02 MX	1624-5000-02	37.00
PT07 MX	1624-5000-07	46.00
PT12 MX	1624-5000-12	58.00
PT17 MX	1624-5000-17	72.00
PT22 MX	1624-5000-22	98.00
PT27 MX	1624-5000-27	117.00
PT32 MX	1624-5000-32	148.00
PT37 MX	1624-5000-37	182.00
PT42 MX	1624-5000-42	208.00
PT47 MX	1624-5000-47	262.00
PT52 MX	1624-5000-52	299.00

Grade AC Activated Carbon

Tiger P/No.	Pn-tech P/No.	List Price £
PT03 AC	1624-5000-03	37.00
PT08 AC	1624-5000-08	46.00
PT13 AC	1624-5000-13	58.00
PT18 AC	1624-5000-18	72.00
PT23 AC	1624-5000-23	98.00
PT28 AC	1624-5000-28	117.00
PT33 AC	1624-5000-33	148.00
PT38 AC	1624-5000-38	182.00
PT43 AC	1624-5000-43	208.00
PT48 AC	1624-5000-48	262.00
PT53 AC	1624-5000-53	299.00



Tiger Filtration Ltd

Unit 3, Rivergreen Industry Centre, Pallion, Sunderland, SR4 6AD, UK

Tel: +44 (0) 191 565 5348 Fax: +44 (0) 191 564 0002

Website: www.tigerfiltration.com Email: sales@tigerfiltration.co.uk

Tiger Filtration Ltd

Puska

Alternative filter elements manufactured by **Tiger Filtration Ltd** to fit into **Puska** filter housings

Tiger P/No.	Puska P/No.	List Price £
PK10 (*)	(*) 10	37.00
PK13 (*)	(*) 13	46.00
PK20 (*)	(*) 20	58.00
PK33 (*)	(*) 33	72.00
PK60 (*)	(*) 60	98.00
PK85 (*)	(*) 85	117.00
PK130 (*)	(*) 130	148.00
PK170 (*)	(*) 170	182.00
PK250 (*)	(*) 250	208.00

(*) = grade - Example: PMO10 order as PK10 M1
M3 replaces PRO (3 Micron)
M1 replaces PMO (1 Micron)
MX replaces PMM (0.01 Micron)
AC replaces PCA (Activated Carbon)

Alternative Filter Elements



Tiger Filtration Ltd

Unit 3, Rivergreen Industry Centre, Pallion, Sunderland, SR4 6AD, UK
Tel: +44 (0) 191 565 5348 Fax: +44 (0) 191 564 0002
Website: www.tigerfiltration.com Email: sales@tigerfiltration.co.uk

Tiger Filtration Ltd

PVR

Alternative air/oil separator elements manufactured by **Tiger Filtration Ltd** to fit into **PVR** vacuum pumps

Alternative Filter Elements



Tiger P/No.	PVR P/No.	Pump Model	List Price £
PV2556	002556	EV45/65	35.00
PV3957	003957	EV105	57.00
PV4391	004391	EV160	42.00
PV3604	003604	EV205/300	49.00
PV5099	005099	EV650	67.00

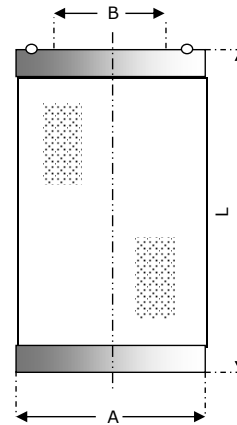

Tiger P/No.	A (mm)	B (mm)	L (mm)
PV2556	74	35	252
PV3957	100	60	260
PV4391	74	35	300
PV3604	80	45	362
PV5099	80	45	528



Tiger Filtration Ltd

Unit 3, Rivergreen Industry Centre, Pallion, Sunderland, SR4 6AD, UK
 Tel: +44 (0) 191 565 5348 Fax: +44 (0) 191 564 0002
 Website: www.tigerfiltration.com Email: sales@tigerfiltration.co.uk

Tiger Filtration Ltd

Rietschle

Alternative filter elements manufactured by **Tiger Filtration Ltd** to fit into **Rietschle** vacuum pumps

Alternative Filter Elements



Tiger P/No.	Rietschle P/No.	Previous Model	List Price £
RT399	731-399	730-946	40.00
RT311	731-311	731-023	42.00
RT400	731-400	730-936	40.00
RT401	731-401	730-937	52.00

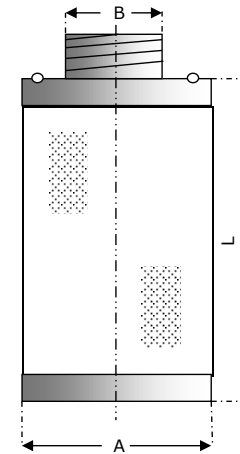

Tiger P/No.	A (mm)	B (mm)	L (mm)
RT399	56	M24	78
RT311	56	M24	123
RT400	72	M33	83
RT401	80	M45	127



Tiger Filtration Ltd

Unit 3, Rivergreen Industry Centre, Pallion, Sunderland, SR4 6AD, UK
 Tel: +44 (0) 191 565 5348 Fax: +44 (0) 191 564 0002
 Website: www.tigerfiltration.com Email: sales@tigerfiltration.co.uk

Tiger Filtration Ltd

Sotras

Alternative filter elements manufactured by **Tiger Filtration Ltd** to fit into **Sotras** filter housings

Alternative Filter Elements



Grade M3(Pre-Filter) 3 Micron

Tiger P/No.	Sotras P/No.	List Price £
ST9017 M3	SM 9017	25.00
ST9021 M3	SM 9021	28.00
ST9025 M3	SM 9025	37.00
ST9029 M3	SM 9029	47.00
ST9033 M3	SM 9033	64.00
ST9037 M3	SM 9037	78.00
ST9041 M3	SM 9041	99.00
ST9045 M3	SM 9045	135.00
ST9049 M3	SM 9049	160.00
ST9053 M3	SM 9053	252.00

Grade M0(Fine Filter) 0.1 Micron

Tiger P/No.	Sotras P/No.	List Price £
ST9018 M0	SM 9018	25.00
ST9022 M0	SM 9022	28.00
ST9026 M0	SM 9026	37.00
ST9030 M0	SM 9030	47.00
ST9034 M0	SM 9034	64.00
ST9038 M0	SM 9038	78.00
ST9042 M0	SM 9042	99.00
ST9046 M0	SM 9046	135.00
ST9050 M0	SM 9050	160.00
ST9054 M0	SM 9054	252.00

Grade MX (Micro Filter) 0.01 Micron

Tiger P/No.	Sotras P/No.	List Price £
ST9019 MX	SM 9019	25.00
ST9023 MX	SM 9023	28.00
ST9027 MX	SM 9027	37.00
ST9031 MX	SM 9031	47.00
ST9035 MX	SM 9035	64.00
ST9039 MX	SM 9039	78.00
ST9043 MX	SM 9043	99.00
ST9047 MX	SM 9047	135.00
ST9051 MX	SM 9051	160.00
ST9055 MX	SM 9055	252.00

Grade AC (Activated Carbon) Activated Carbon

Tiger P/No.	Sotras P/No.	List Price £
ST9020 AC	SM 9020	25.00
ST9024 AC	SM 9024	28.00
ST9028 AC	SM 9028	37.00
ST9032 AC	SM 9032	47.00
ST9036 AC	SM 9036	64.00
ST9040 AC	SM 9040	78.00
ST9044 AC	SM 9044	99.00
ST9048 AC	SM 9048	135.00
ST9052 AC	SM 9052	160.00
ST9056 AC	SM 9056	252.00



Tiger Filtration Ltd

Unit 3, Rivergreen Industry Centre, Pallion, Sunderland, SR4 6AD, UK
 Tel: +44 (0) 191 565 5348 Fax: +44 (0) 191 564 0002
 Website: www.tigerfiltration.com Email: sales@tigerfiltration.co.uk

Tiger Filtration Ltd

Sullair

Alternative filter elements manufactured by **Tiger Filtration Ltd** to fit into **Sullair** filter housings

Alternative Filter Elements



Grade M1 1 Micron

Tiger P/No.	Sullair P/No.	List Price £
SU423 M1	250024-423	40.00
SU424 M1	250024-424	67.00
SU425 M1	250024-425	78.00
SU426 M1	250024-426	97.00
SU427 M1	250024-427	127.00
SU428 M1	250024-428	151.00
SU429 M1	250024-429	218.00
SU644 M1	250024-644	258.00
SU430 M1	250024-430	349.00

Grade MX 0.01 Micron

Tiger P/No.	Sullair P/No.	List Price £
SU431 MX	250024-431	40.00
SU432 MX	250024-432	67.00
SU433 MX	250024-433	78.00
SU434 MX	250024-434	97.00
SU435 MX	250024-435	127.00
SU436 MX	250024-436	151.00
SU437 MX	250024-437	218.00
SU655 MX	250024-655	258.00
SU438 MX	250024-438	349.00

Grade AC Activated Carbon

Tiger P/No.	Sullair P/No.	List Price £
SU443 AC	250024-443	40.00
SU444 AC	250024-444	67.00
SU445 AC	250024-445	78.00
SU446 AC	250024-446	97.00
SU447 AC	250024-447	127.00
SU439 AC	250024-439	151.00
SU440 AC	250024-440	218.00
SU646 AC	250024-646	258.00
SU441 AC	250024-441	349.00



Tiger Filtration Ltd

Unit 3, Rivergreen Industry Centre, Pallion, Sunderland, SR4 6AD, UK
 Tel: +44 (0) 191 565 5348 Fax: +44 (0) 191 564 0002
 Website: www.tigerfiltration.com Email: sales@tigerfiltration.co.uk

Tiger Filtration Ltd

Tepro

Alternative air/oil separator elements manufactured by **Tiger Filtration Ltd** to fit into **Tepro** vacuum pumps

Alternative Filter Elements



Tiger P/No.	Tepro P/No.	Pump Model	List Price £
TP713	FPS70x130	AT21/21A	25.00
TP716	FPS70x160	AT21B/40B	28.00
TP725	FPS70x250	AT63B/100B	37.00

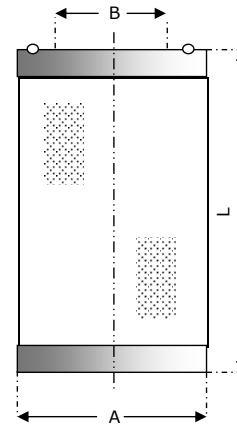

Tiger P/No.	A (mm)	B (mm)	L (mm)
TP713	70	29 (ID)	130
TP716	70	29 (ID)	160
TP725	70	29 (ID)	250



Tiger Filtration Ltd

Unit 3, Rivergreen Industry Centre, Pallion, Sunderland, SR4 6AD, UK
 Tel: +44 (0) 191 565 5348 Fax: +44 (0) 191 564 0002
 Website: www.tigerfiltration.com Email: sales@tigerfiltration.co.uk

Tiger Filtration Ltd

Alternative Filter Elements

Ultrafilter (Donaldson) DF Series - Current

Alternative filter elements supplied by **Tiger Filtration Ltd** to fit into **Donaldson Ultrafilter DF** filter housings



Grade M25				25 Micron				Grade M1				1 Micron				Grade M0				0.1 Micron																																																																																							
Tiger P/no.	UF P/No.	Housing No.	NETT Price £	Tiger P/no.	UF P/No.	Housing No.	NETT Price £	Tiger P/no.	UF P/No.	Housing No.	NETT Price £	Tiger P/no.	UF P/No.	Housing No.	NETT Price £	Tiger P/no.	UF P/No.	Housing No.	NETT Price £																																																																																								
DF0035-M25	1C486004	0035P	27.00	DF0035-M1	1C486003	0035V	27.00	DF0035-M0	1C486001	0035M	27.00	DF0070-M25	1C486014	0070P	33.00	DF0070-M1	1C486013	0070V	33.00	DF0070-M0	1C486011	0070M	33.00	DF0120-M25	1C486024	0120P	39.00	DF0120-M1	1C486023	0120V	39.00	DF0120-M0	1C486021	0120M	39.00	DF0210-M25	1C486034	0210P	47.00	DF0210-M1	1C486033	0210V	47.00	DF0210-M0	1C486031	0210M	47.00	DF0320-M25	1C486044	0320P	56.00	DF0320-M1	1C486043	0320V	56.00	DF0320-M0	1C486041	0320M	56.00	DF0450-M25	1C486054	0450P	74.00	DF0450-M1	1C486053	0450V	74.00	DF0450-M0	1C486051	0450M	74.00	DF0600-M25	1C486064	0600P	82.00	DF0600-M1	1C486063	0600V	82.00	DF0600-M0	1C486061	0600M	82.00	DF0750-M25	1C486074	0750P	90.00	DF0750-M1	1C486073	0750V	90.00	DF0750-M0	1C486071	0750M	90.00	DF1100-M25	1C486084	1100P	119.00	DF1100-M1	1C486083	1100V	119.00	DF1100-M0	1C486081	1100M	119.00

Grade MX				0.01 Micron				Grade AC				Activated Carbon																																																											
Tiger P/no.	UF P/No.	Housing No.	NETT Price £	Tiger P/no.	UF P/No.	Housing No.	NETT Price £	Tiger P/no.	UF P/No.	Housing No.	NETT Price £	Tiger P/no.	UF P/No.	Housing No.	NETT Price £																																																								
DF0035-MX	1C486000	0035S	27.00	DF0035-AC	1C486006	0035A	27.00	DF0070-MX	1C486010	0070S	33.00	DF0070-AC	1C486016	0070A	33.00	DF0120-MX	1C486020	0120S	39.00	DF0120-AC	1C486026	0120A	39.00	DF0210-MX	1C486030	0210S	47.00	DF0210-AC	1C486036	0210A	47.00	DF0320-MX	1C486040	0320S	56.00	DF0320-AC	1C486046	0320A	56.00	DF0450-MX	1C486050	0450S	74.00	DF0450-AC	1C486056	0450A	74.00	DF0600-MX	1C486060	0600S	82.00	DF0600-AC	1C486066	0600A	82.00	DF0750-MX	1C486070	0750S	90.00	DF0750-AC	1C486076	0750A	90.00	DF1100-MX	1C486080	1100S	119.00	DF1100-AC	1C486086	1100A	119.00



Tiger Filtration Ltd

Unit 3, Rivergreen Industry Centre, Pallion, Sunderland, SR4 6AD, UK
 Tel: +44 (0) 191 565 5348 Fax: +44 (0) 191 564 0002
 Website: www.tigerfiltration.com Email: sales@tigerfiltration.co.uk

Tiger Filtration Ltd

Ultrafilter (Donaldson) 90 Series

Alternative filter elements manufactured by **Tiger Filtration Ltd** to fit into **Donaldson Ultrafilter (90 Series)** filter housings

Alternative Filter Elements



Standard Elements

Tiger P/no.	UF P/No.	List Price £
UF0205 (*)	(*) 02/05	46.00
UF0210 (*)	(*) 02/10	47.00
UF0305 (*)	(*) 03/05	52.00
UF0310 (*)	(*) 03/10	59.00
UF0410 (*)	(*) 04/10	65.00
UF0420 (*)	(*) 04/20	76.00
UF0520 (*)	(*) 05/20	85.00
UF0525 (*)	(*) 05/25	98.00
UF0725 (*)	(*) 07/25	113.00
UF0730 (*)	(*) 07/30	135.00
UF1030 (*)	(*) 10/30	168.00
UF1530 (*)	(*) 15/30	186.00
UF2030 (*)	(*) 20/30	218.00
UF3030 (*)	(*) 30/30	297.00
UF3050 (*)	(*) 30/50	438.00

(*) = grade - Example: FF02/05 order as UF0205 M1
 M25 replaces V-PE (25 Micron)
 M1 replaces FF (1 Micron)
 M0 replaces MF (0.1 Micron & oil removal)
 MX replaces SMF (0.01 Micron & 0.01mg/m³ oil removal)
 AC replaces AK (Activated Carbon)

HT/CR or HT/NX Range

Tiger P/no.	UF P/No.	Nett Price £
UFHT0205 (*)	(*) 02/05	POA
UFHT0305 (*)	(*) 03/05	POA
UFHT0310 (*)	(*) 03/10	POA
UFHT0410 (*)	(*) 04/10	POA
UFHT0420 (*)	(*) 04/20	POA
UFHT0520 (*)	(*) 05/20	POA
UFHT0525 (*)	(*) 05/25	POA
UFHT0725 (*)	(*) 07/25	POA
UFHT0730 (*)	(*) 07/30	POA
UFHT1030 (*)	(*) 10/30	POA
UFHT1530 (*)	(*) 15/30	POA
UFHT2030 (*)	(*) 20/30	POA
UFHT3030 (*)	(*) 30/30	POA
UFHT3050 (*)	(*) 30/50	POA

(*) = grade - Example: FF02/05 order as UFHT0205 M1
 M1 replaces FF (1 Micron)
 M0 replaces MF (0.1 Micron & oil removal)
 MX replaces SMF (0.01 Micron & 0.01mg/m³ oil removal)



Tiger Filtration Ltd

Unit 3, Rivergreen Industry Centre, Pallion, Sunderland, SR4 6AD, UK
 Tel: +44 (0) 191 565 5348 Fax: +44 (0) 191 564 0002
 Website: www.tigerfiltration.com Email: sales@tigerfiltration.co.uk

Tiger Filtration Ltd

Alternative Filter Elements

Ultrafilter (Donaldson) 90 Series Sterile Filters

Alternative filter elements manufactured by **Tiger Filtration Ltd** to fit into **Donaldson Ultrafilter (90 Series)** filter housings



Standard Elements

Tiger P/no.	UF P/No.	NETT Price £
UF0205-(*)	SRF 02/05	40.00
UF0210-(*)	SRF 02/10	41.00
UF0305-(*)	SRF 03/05	38.00
UF0310-(*)	SRF 03/10	46.00
UF0410-(*)	SRF 04/10	50.00
UF0420-(*)	SRF 04/20	52.00
UF0520-(*)	SRF 05/20	58.00
UF0525-(*)	SRF 05/25	65.00
UF0725-(*)	SRF 07/25	81.00
UF0730-(*)	SRF 07/30	93.00
UF1030-(*)	SRF 10/30	113.00
UF1530-(*)	SRF 15/30	132.00
UF2030-(*)	SRF 20/30	171.00
UF3030-(*)	SRF 30/30	196.00
UF3050-(*)	SRF 30/50	334.00

Please indicate if threaded (SR) or push-fit (PSR) versions are required

(*) = SR for threaded or PSR for push-fit connections - Example: UF0205-SR for threaded option



Tiger Filtration Ltd

Unit 3, Rivergreen Industry Centre, Pallion, Sunderland, SR4 6AD, UK
Tel: +44 (0) 191 565 5348 Fax: +44 (0) 191 564 0002
Website: www.tigerfiltration.com Email: sales@tigerfiltration.co.uk

Tiger Filtration Ltd

Ultrafilter (Donaldson) 80 Series

Alternative filter elements manufactured by **Tiger Filtration Ltd** to fit into **Donaldson Ultrafilter (80 Series)** filter housings

Alternative Filter Elements



Standard Elements

Tiger P/No.	UF P/No.	List Price £
UF425 (*)	(*) 4/2.5	97.00
UF525 (*)	(*) 5/2.5	98.00
UF53 (*)	(*) 5/3	131.00
UF103 (*)	(*) 10/3	166.00
UF153 (*)	(*) 15/3	186.00
UF203 (*)	(*) 20/3	215.00
UF303 (*)	(*) 30/3	269.00
UF305 (*)	(*) 30/5	416.00

(*) = grade - Example: FF4/2.5 order as UF425 M1

M25 replaces V (25 Micron)

M1 replaces FF (1 Micron)

M0 replaces MF (0.1 Micron & oil removal)

MX replaces SMF (0.01 Micron & 0.01mg/m³ oil removal)

AC replaces AK (Activated Carbon)

HT/CR or HT/NX Range

Tiger P/No.	UF P/No.	Nett Price £
UFHT 103 (*)	(*) 10/3	POA
UFHT 153 (*)	(*) 15/3	POA
UFHT 203 (*)	(*) 20/3	POA
UFHT 303 (*)	(*) 30/3	POA
UFHT 305 (*)	(*) 30/5	POA

(*) = grade - Example: FF103 order as UFHT103 M1

M1 replaces FF (1 Micron)

M0 replaces MF (0.1 Micron & oil removal)

MX replaces SMF (0.01 Micron & 0.01mg/m³ oil removal)



Tiger Filtration Ltd

Unit 3, Rivergreen Industry Centre, Pallion, Sunderland, SR4 6AD, UK

Tel: +44 (0) 191 565 5348 Fax: +44 (0) 191 564 0002

Website: www.tigerfiltration.com Email: sales@tigerfiltration.co.uk

Tiger Filtration Ltd

Alternative Filter Elements

Ultrafilter (Donaldson) 80 Series Sterile Filters

Alternative filter elements manufactured by **Tiger Filtration Ltd** to fit into **Donaldson Ultrafilter (80 Series)** filter housings



Standard Elements

Tiger P/No.	UF P/No.	NETT Price £
UF310 SR	SRF 3/1	40.00
UF315 SR	SRF 3/1.5	51.00
UF415 SR	SRF 4/1.5	55.00
UF425 SR	SRF 4/2.5	65.00
UF525 SR	SRF 5/2.5	71.00
UF53 SR	SRF 5/3	85.00
UF103 SR	SRF 10/3	108.00
UF153 SR	SRF 15/30	126.00
UF203 SR	SRF 20/3	155.00
UF303 SR	SRF 30/3	175.00
UF305 SR	SRF 30/5	309.00



Tiger Filtration Ltd

Unit 3, Rivergreen Industry Centre, Pallion, Sunderland, SR4 6AD, UK
Tel: +44 (0) 191 565 5348 Fax: +44 (0) 191 564 0002
Website: www.tigerfiltration.com Email: sales@tigerfiltration.co.uk

Tiger Filtration Ltd

Van Air Systems

Alternative filter elements manufactured by **Tiger Filtration Ltd** to fit into **Van Air Systems** filter housings

A Range

Tiger P/No.	Van Air P/No.	List Price £
VA200-15 (*)	E200-15 (*)	39.00
VA200-25 (*)	E200-25 (*)	56.00
VA200-55 (*)	E200-55 (*)	66.00
VA200-85 (*)	E200-85 (*)	96.00
VA200-100 (*)	E200-100 (*)	113.00
VA200-150 (*)	E200-150 (*)	130.00
VA200-265 (*)	E200-265 (*)	144.00
VA200-350 (*)	E200-350 (*)	174.00
VA200-400 (*)	E200-400 (*)	174.00
VA200-500 (*)	E200-500 (*)	215.00
VA200-600 (*)	E200-600 (*)	255.00
VA200-800 (*)	E200-800 (*)	337.00
VA200-1000 (*)	E200-1000 (*)	398.00

(*) = grade - Example: E200-15 B order as VA200-15 M1
 M25 replaces AA (25 Micron)
 M5 replaces A (5 Micron)
 M1 replaces B (1 Micron)
 MX replaces C (0.01 micron)
 AC replaces D (Activated Carbon)

Alternative Filter Elements



Previous

Tiger P/No.	Van Air P/No.	List Price £
VA100-15 (*)	E100-15 (*)	54.00
VA100-30 (*)	E100-30 (*)	66.00
VA100-50 (*)	E100-50 (*)	73.00
VA100-75 (*)	E100-75 (*)	96.00
VA100-100 (*)	E100-100 (*)	112.00
VA100-150 (*)	E100-150 (*)	130.00
VA100-225 (*)	E100-225 (*)	144.00
VA100-350 (*)	E100-350 (*)	174.00
VA100-500 (*)	E100-500 (*)	212.00
VA100-750 (*)	E100-750 (*)	338.00
VA100-1000 (*)	E100-1000 (*)	398.00
VA101/102-500 (*)	E101/102-500 (*)	208.00
VA101/102-625 (*)	E101/102-625 (*)	225.00

(*) = grade - Example: E100-15 B order as VA100-15 M1
 M25 replaces AA (25 Micron)
 M5 replaces A (5 Micron)
 M1 replaces B (1 Micron)
 MX replaces C (0.01 micron)
 AC replaces D (Activated Carbon)



Tiger Filtration Ltd

Unit 3, Rivergreen Industry Centre, Pallion, Sunderland, SR4 6AD, UK
 Tel: +44 (0) 191 565 5348 Fax: +44 (0) 191 564 0002
 Website: www.tigerfiltration.com Email: sales@tigerfiltration.co.uk

Tiger Filtration Ltd

Walker Alpha Series - Current

Alternative filter elements manufactured by **Tiger Filtration Ltd** to fit into **Walker** filter housings

Alternative Filter Elements



Tiger P/No.	Walker P/No.	List Price £
WF0304 (*)	E0304 (*)	39.00
WF0305 (*)	E0305 (*)	43.00
WF0406 (*)	E0406 (*)	48.00
WF0407 (*)	E0407 (*)	55.00
WF0413 (*)	E0413 (*)	67.00
WF0613 (*)	E0613 (*)	75.00
WF0620 (*)	E0620 (*)	97.00
WF0625 (*)	E0625 (*)	117.00
WF0730 (*)	E0730 (*)	139.00
WF0830 (*)	E0830 (*)	160.00
WF0860 (*)	E0860 (*)	206.00
WF1140 (*)	E1140 (*)	253.00
WF1160 (*)	E1160 (*)	332.00
WF1175 (*)	E1175 (*)	373.00

(*) = grade - Example: E1003 X1 order as WF1003 M1
M25 replaces X25 (25 Micron)
M5 replaces X5 (5 Micron)
M1 replaces X1 (1 Micron)
MX replaces XA (0.01 micron & 0.01mg/m³ oil removal)
AC replaces AC (Activated Carbon)



Tiger Filtration Ltd

Unit 3, Rivergreen Industry Centre, Pallion, Sunderland, SR4 6AD, UK
Tel: +44 (0) 191 565 5348 Fax: +44 (0) 191 564 0002
Website: www.tigerfiltration.com Email: sales@tigerfiltration.co.uk

Tiger Filtration Ltd

Walker - Previous

Alternative filter elements manufactured by **Tiger Filtration Ltd** to fit into **Walker** filter housings

Tiger P/No.	Walker P/No.	List Price £
WF361 (*)	E361 (*)	39.00
WF381 ACC	E381 AC	30.00
WF371 (*)	E371 (*)	56.00
WF511 (*)	E511 (*)	66.00
WF711 (*)	E711 (*)	96.00
WF811 (*)	E811 (*)	113.00
WF731 (*)	E731 (*)	130.00
WF821 (*)	E821 (*)	144.00
WF831 (*)	E831 (*)	174.00
WF851 (*)	E851 (*)	215.00
WF1251 (*)	E1251 (*)	255.00
WF1261 (*)	E1261 (*)	337.00
WF1281 (*)	E1281 (*)	398.00
WF139 (*)	E139 (*)	445.00
WF88 (*)	E88 (*)	240.00

(*) = grade - Example: E361 X1 order as WF361 M1
M25 replaces X25 (25 Micron)
M5 replaces X5 (5 Micron)
M1 replaces X1 (1 Micron)
MX replaces XA (0.01 micron)
AC replaces AC (Activated Carbon)

Medical Vacuum Elements

Tiger P/No.	Walker P/No.	List Price £
WF511 MV	E511 MV	66.00
WF521 MV	E521 MV	85.00
WF811 MV	E811 MV	113.00
WF821 MV	E821 MV	144.00
WF831 MV	E831 MV	174.00
WF851 MV	E851 MV	215.00
WF1261 MV	E1261 MV	337.00
WF1281 MV	E1281 MV	398.00
WF139 MV	E139 MV	579.00
WF88 MV	E88 MV	263.00



Tiger Filtration Ltd

Unit 3, Rivergreen Industry Centre, Pallion, Sunderland, SR4 6AD, UK
Tel: +44 (0) 191 565 5348 Fax: +44 (0) 191 564 0002
Website: www.tigerfiltration.com Email: sales@tigerfiltration.co.uk

Alternative Filter Elements



High Pressure Elements - 50 Barg

Tiger P/No.	Walker P/No.	List Price £
WF50 (*)	E50 (*)	54.00
WF51 (*)	E51 (*)	66.00
WF52 (*)	E52 (*)	73.00
WF715 (*)	E715 (*)	96.00
WF730 (*)	E730 (*)	130.00
WF830 (*)	E830 (*)	144.00
WF86 (*)	E86 (*)	208.00

High Pressure Elements - 100 Barg

Tiger P/No.	Walker P/No.	List Price £
WFHP371 (*)	HP371 (*)	91.00
WFHP381 (*)	HP381 (*)	110.00
WFHP420 (*)	HP420 (*)	133.00
WFHP710 (*)	HP710 (*)	162.00
WFHP730 (*)	HP730 (*)	188.00
WFHP830 (*)	HP830 (*)	207.00
WFHP860 (*)	HP860 (*)	285.00

High Pressure Elements - 350 Barg

Tiger P/No.	Walker P/No.	List Price £
WFHP261 (*)	HP261 (*)	67.00
WFHP371 (*)	HP371 (*)	91.00
WFHP410 (*)	HP410 (*)	111.00
WFHP420 (*)	HP420 (*)	133.00
WFHP710 (*)	HP710 (*)	162.00
WFHP730 (*)	HP730 (*)	188.00

(*) = grade - Example: E50 X1 order as WF50 M1
M25 replaces X25 (25 Micron)
M5 replaces X5 (5 Micron)
M1 replaces X1 (1 Micron)
MX replaces XA (0.01 micron)
AC replaces AC (Activated Carbon)

Tiger Filtration Ltd

Walker - Alloy High Pressure Elements

Alternative filter elements manufactured by **Tiger Filtration Ltd** to fit into **Walker** filter housings

20 Bar Alloy High Pressure

Tiger P/No.	Walker P/No.	List Price £
WF1003 (*)	E1003 (*)	56.00
WF1503 (*)	E1503 (*)	56.00
WF2005 (*)	E2005 (*)	82.00
WF2505 (*)	E2505 (*)	118.00
WF2008 (*)	E2008 (*)	118.00
WF2508 (*)	E2508 (*)	145.00
WF2512 (*)	E2512 (*)	171.00
WF2712 (*)	E2712 (*)	193.00
WF3012 (*)	E3012 (*)	212.00
WF3020 (*)	E3020 (*)	250.00
WF5020 (*)	E5020 (*)	308.00
WF5024 (*)	E5024 (*)	406.00
WF5030 (*)	E5030 (*)	458.00

(*) = grade - Example: E1003 X1 order as WF1003 M1
 M25 replaces X25 (25 Micron)
 M5 replaces X5 (5 Micron)
 M1 replaces X1 (1 Micron)
 MX replaces XA (0.01 micron)
 AC replaces AC (Activated Carbon)

Alternative Filter Elements



50 Bar Alloy High Pressure

Tiger P/No.	Walker P/No.	List Price £
WFHP1535 (*)	HP1535 (*)	66.00
WFHP1550 (*)	HP1550 (*)	71.00
WFHP2040 (*)	HP2040 (*)	83.00
WFHP2540 (*)	HP2540 (*)	109.00
WFHP2080 (*)	HP2080 (*)	149.00
WFHP2580 (*)	HP2580 (*)	176.00
WFHP2512 (*)	HP2512 (*)	242.00
WFHP2520 (*)	HP2520 (*)	311.00

(*) = grade - Example: HP1535 X1 order as WFHP1535 M1
 M25 replaces X25 (25 Micron)
 M5 replaces X5 (5 Micron)
 M1 replaces X1 (1 Micron)
 MX replaces XA (0.01 micron)
 AC replaces AC (Activated Carbon)



Tiger Filtration Ltd

Unit 3, Rivergreen Industry Centre, Pallion, Sunderland, SR4 6AD, UK
 Tel: +44 (0) 191 565 5348 Fax: +44 (0) 191 564 0002
 Website: www.tigerfiltration.com Email: sales@tigerfiltration.co.uk

Tiger Filtration Ltd

Walker - Medical Sterile Elements - A Range and Previous

Alternative filter elements manufactured by **Tiger Filtration Ltd** to fit into **Walker** filter housings

Medical Sterile A Range

Tiger P/No.	Walker P/No.	List Price £
WF361 SR	E361 SR	79.00
WF371 SR	E371 SR	97.00
WF511 SR	E511 SR	106.00
WF711 SR	E711 SR	141.00
WF811 SR	E811 SR	158.00
WF731 SR	E731 SR	174.00
WF821 SR	E821 SR	217.00
WF831 SR	E831 SR	251.00
WF851 SR	E851 SR	366.00
WF1251 SR	E1251 SR	482.00
WF1261 SR	E1261 SR	561.00
WF1281 SR	E1281 SR	702.00

Alternative Filter Elements



Medical Sterile - Previous

Tiger P/No.	Walker P/No.	List Price £
WF50 SR	E50 SR	83.00
WF51 SR	E51 SR	100.00
WF52 SR	E52 SR	110.00
WF71 SR	E71 SR	145.00
WF81 SR	E81 SR	165.00
WF73 SR	E73 SR	181.00
WF83 SR	E83 SR	196.00
WF831 SR	E831 SR	251.00
WF123 SR	E123 SR	375.00
WF125 SR	E125 SR	496.00
WF134 SR	E134 SR	375.00
WF135 SR	E135 SR	502.00
WF127 SR	E127 SR	579.00
WF128 SR	E128 SR	719.00



Tiger Filtration Ltd

Unit 3, Rivergreen Industry Centre, Pallion, Sunderland, SR4 6AD, UK
Tel: +44 (0) 191 565 5348 Fax: +44 (0) 191 564 0002
Website: www.tigerfiltration.com Email: sales@tigerfiltration.co.uk

Tiger Filtration Ltd

Walker - Previous

Alternative filter elements manufactured by **Tiger Filtration Ltd** to fit into **Walker** filter housings

Tiger P/No.	Walker P/No.	List Price £
WF50 (*)	E50 (*)	54.00
WF51 (*)	E51 (*)	66.00
WF52 (*)	E52 (*)	73.00
WF71 (*)	E71 (*)	96.00
WF81 (*)	E81 (*)	112.00
WF73 (*)	E73 (*)	130.00
WF83 (*)	E83 (*)	144.00
WF103 (*)	E103 (*)	174.00
WF123 (*)	E123 (*)	212.00
WF125 (*)	E125 (*)	255.00
WF134 (*)	E134 (*)	215.00
WF135 (*)	E135 (*)	255.00
WF127 (*)	E127 (*)	338.00
WF128 (*)	E128 (*)	387.00
WF830 (*)	E830 (*)	144.00
WF86 (*)	E86 (*)	208.00
WF87 (*)	E87 (*)	225.00
WF137 (*)	E137 (*)	321.00
WF138 (*)	E138 (*)	406.00

(*) = grade - Example: E50 X1 order as WF50 M1
 M25 replaces X25 (25 Micron)
 M5 replaces X5 (5 Micron)
 M1 replaces X1 (1 Micron)
 MX replaces XA (0.01 micron)
 AC replaces AC (Activated Carbon)

Alternative Filter Elements



Medical Vacuum Elements

Tiger P/No.	Walker P/No.	List Price £
WF27 MV	E27 MV	50.00
WF37 MV	E37 MV	62.00
WF57 MV	E57 MV	77.00
WF81 MV	E81 MV	109.00
WF83 MV	E83 MV	165.00
WF103 MV	E103 MV	197.00
WF133 MV	E133 MV	240.00
WF137 MV	E137 MV	307.00
WF138 MV	E138 MV	343.00

High Pressure Elements

Tiger P/No.	Walker P/No.	List Price £
WFHP260 (*)	HP260 (*)	67.00
WFHP310 (*)	HP310 (*)	91.00

(*) = grade - Example: HP260 X1 order as WFHP260 M1
 M25 replaces X25 (25 Micron)
 M5 replaces X5 (5 Micron)
 M1 replaces X1 (1 Micron)
 MX replaces XA (0.01 micron)
 AC replaces AC (Activated Carbon)



Tiger Filtration Ltd

Unit 3, Rivergreen Industry Centre, Pallion, Sunderland, SR4 6AD, UK
 Tel: +44 (0) 191 565 5348 Fax: +44 (0) 191 564 0002
 Website: www.tigerfiltration.com Email: sales@tigerfiltration.co.uk

Tiger Filtration Ltd

Alternative Filter Elements

Walker - Odasorb Exhaust Filters

Alternative filter elements manufactured by **Tiger Filtration Ltd** for rotary type vane pumps with internal oil separation



Tiger P/No.	Pipe size	NETT Price £
TFOS50	3/4"	34.00
TFOS75	1"	48.00
TFOS100	1 1/4"	58.00
TFOS150	1 1/2"	80.00
TFOS200	2"	102.00

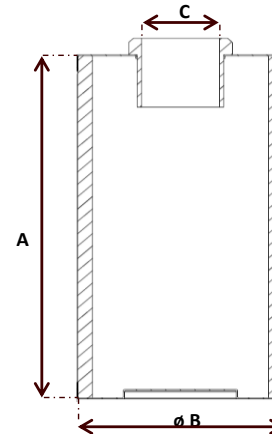

Tiger P/No.	A (mm)	B (mm)	C (Pipe Size)
TFOS50	80	150	3/4"
TFOS75	100	150	1"
TFOS100	130	150	1 1/4"
TFOS150	130	250	1 1/2"
TFOS200	130	300	2"
Technical Data			
Maximum Temperature	120°C / 248°F		
Element End Cap Material	TFOS50 & TFOS75 - Aluminium TFOS100, TFOS150 & TFOS200 - Zinc Plated Steel		



Tiger Filtration Ltd

Unit 3, Rivergreen Industry Centre, Pallion, Sunderland, SR4 6AD, UK
 Tel: +44 (0) 191 565 5348 Fax: +44 (0) 191 564 0002
 Website: www.tigerfiltration.com Email: sales@tigerfiltration.co.uk

Tiger Filtration Ltd

Alternative Filter Elements

Walker - Autoclave Filter elements

Autoclave filters for sterilising atmospheric air entering hospital and laboratory sterilisers at vacuum break cycle



Tiger P/No.	Walker P/No.	NETT Price £
WFAF1	AF1	16.00
WFAF1-SOCK Pack of 10	AF1 Socks	9.00
WFAF2	AF2	19.00
WFAF2-SOCK Pack of 10	AF2 Socks	12.00

Pipe Size	flow rate		dimensions (mm)			weight Kg
	Nm ³ /Hr	SCFM	A	B	C	
Rp 1/2	20	12	133	104	82	0.19
Rp 3/4	40	24	213	184	82	0.26

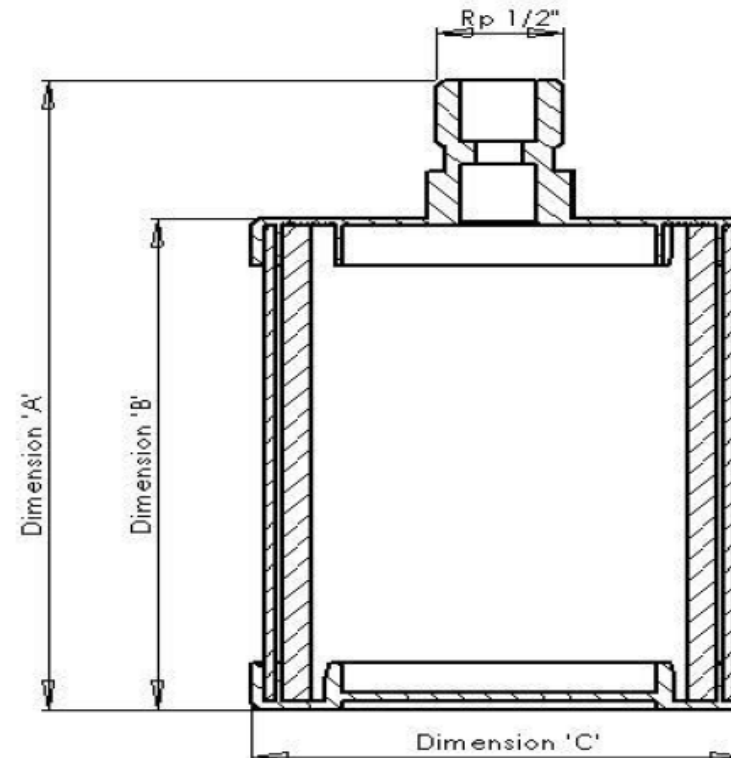

Tiger Filtration Ltd

Unit 3, Rivergreen Industry Centre, Pallion, Sunderland, SR4 6AD, UK
 Tel: +44 (0) 191 565 5348 Fax: +44 (0) 191 564 0002
 Website: www.tigerfiltration.com Email: sales@tigerfiltration.co.uk

Tiger Filtration Ltd

Alternative Filter Elements

Worthington Creyssensac

Alternative filter elements manufactured by **Tiger Filtration Ltd** to fit into **Worthington Creyssensac** filter housings



Tiger P/No.	Worthington P/No.	List Price £
WC60 (*)	D60 (*)	37.00
WC80 (*)	D80 (*)	46.00
WC120 (*)	D120 (*)	58.00
WC200 (*)	D200 (*)	72.00
WC340 (*)	D340 (*)	98.00
WC510 (*)	D510 (*)	117.00
WC800 (*)	D800 (*)	148.00
WC1000 (*)	D1000 (*)	182.00
WC1500 (*)	D1500 (*)	208.00
WC2400 (*)	D2400 (*)	299.00

(*) = grade - Example: D60 D order as WC60 M1

M3 replaces P (3 Micron)

M1 replaces D (1 Micron)

M0 replaces M (0.1 Micron)

MX replaces S (0.01 Micron)

AC replaces A (Activated Carbon)



Tiger Filtration Ltd

Unit 3, Rivergreen Industry Centre, Pallion, Sunderland, SR4 6AD, UK

Tel: +44 (0) 191 565 5348 Fax: +44 (0) 191 564 0002

Website: www.tigerfiltration.com Email: sales@tigerfiltration.co.uk

Tiger Filtration Ltd

Zander (Parker) GL Series - Current

Alternative filter elements by **Tiger Filtration Ltd** to fit into **Zander (Parker) GL** filter housings

Alternative Filter Elements



Tiger P/No.	Zander P/No.	NETT Price £
ZA1008 (*)	CP1008(*)	24.00
ZA2010 (*)	CP2010(*)	29.00
ZA2020 (*)	CP2020(*)	33.00
ZA3025 (*)	CP3025(*)	36.00
ZA3040 (*)	CP3040(*)	40.00
ZA4040 (*)	CP4040(*)	57.00
ZA4050 (*)	CP4050(*)	68.00
ZA4065 (*)	CP4065(*)	82.00
ZA5065 (*)	CP5065(*)	94.00
ZA5080 (*)	CP5080(*)	134.00

(*) = grade - Example: CP1008ZL order as ZA1008 M1

M3 replaces VL (3 Micron)

M1 replaces ZL (1 Micron)

MX replaces XL (0.01 Micron Dust Removal)

AC replaces A (Activated Carbon) - Single Stage



Tiger Filtration Ltd

Unit 3, Rivergreen Industry Centre, Pallion, Sunderland, SR4 6AD, UK

Tel: +44 (0) 191 565 5348 Fax: +44 (0) 191 564 0002

Website: www.tigerfiltration.com Email: sales@tigerfiltration.co.uk

Tiger Filtration Ltd

Zander (Parker) - Previous

Alternative filter elements manufactured by **Tiger Filtration Ltd** to fit into **Zander (Parker)** filter housings

Alternative Filter Elements



Tiger P/No.	Zander P/No.	List Price £
ZA103 (*)	1030 (*)	60.00
ZA105 (*)	1050 (*)	70.00
ZA107 (*)	1070 (*)	82.00
ZA114 (*)	1140 (*)	102.00
ZA201 (*)	2010 (*)	135.00
ZA202 (*)	2020 (*)	173.00
ZA203 (*)	2030 (*)	215.00
ZA205 (*)	2050 (*)	277.00
ZA305 (*)	3050 (*)	325.00
ZA307 (*)	3075 (*)	380.00
ZA506 (*)	5060 (*)	523.00
ZA507 (*)	5075 (*)	631.00

(*) = grade - Example: 1050 Z order as ZA105 M1

M5 replaces V (5 Micron)

M1 replaces Z (1 Micron)

M0 replaces Y (0.1 Micron)

MX replaces X (0.01 Micron & 0.01mg/m³ oil removal)

AC replaces A (Activated Carbon)



Tiger Filtration Ltd

Unit 3, Rivergreen Industry Centre, Pallion, Sunderland, SR4 6AD, UK

Tel: +44 (0) 191 565 5348 Fax: +44 (0) 191 564 0002

Website: www.tigerfiltration.com Email: sales@tigerfiltration.co.uk

Tiger Filtration Ltd

Zeks

Alternative filter elements manufactured by **Tiger Filtration Ltd** to fit into **Zeks** filter housings

Alternative Filter Elements



Tiger P/No.	Zeks P/No.	List Price £
ZK15 (*)	E15 (*)	31.00
ZK30 (*)	E30 (*)	32.00
ZK32 (*)	E32 (*)	33.00
ZK65 (*)	E65 (*)	41.00
ZK80 (*)	E80 (*)	58.00
ZK100 (*)	E100 (*)	73.00
ZK150 (*)	E150 (*)	84.00
ZK250 (*)	E250 (*)	148.00
ZK300 (*)	E300 (*)	160.00
ZK500 (*)	E500 (*)	200.00
ZK650 (*)	E650 (*)	210.00
ZK1000 (*)	E1000 (*)	274.00
ZK1250 (*)	E1250 (*)	300.00
ZK1600 (*)	E1600 (*)	401.00

(*) = grade - Example: E15 G order as ZK15 M1

M5 replaces P (5 Micron)

M1 replaces G (1 Micron)

MX replaces H (0.01 Micron & 0.01mg/m³ oil removal)

AC replaces A (Activated Carbon)



Tiger Filtration Ltd

Unit 3, Rivergreen Industry Centre, Pallion, Sunderland, SR4 6AD, UK

Tel: +44 (0) 191 565 5348 Fax: +44 (0) 191 564 0002

Website: www.tigerfiltration.com Email: sales@tigerfiltration.co.uk